

# CMBSPO7

## Sockets and plugs

- Group IIC
- Zone 1, 2, 21, 22
- Plugs and sockets made of GRP material
- Enhanced operational safety
- Available in a wide range of current ratings



## Series CMBSP07... Sockets and plugs - plastic material

The CMBSP07 series increased-safety GRP plugs and sockets are available in 16A, 32A, 63A, and 125A versions with 3, 4, or 5 poles. Thanks to the interlocked switch-disconnector, the plug can be removed only after the power switch has been turned off, and the power switch can be turned on only after the plug has been correctly inserted.

The plug pin, when mated with the socket contact, features a spring-loaded elastic element that not only makes the electrical contacts self-cleaning, but also ensures low contact/insertion resistance and limited temperature rise. In addition, it minimizes the insertion and extraction force required.

### Sectors of application:



Petroleum refineries



Chemical and petrochemical plants



Onshore facilities



Offshore facilities



Petroleum loading/unloading pontoons



Low temperatures



Fuel storage facilities



Agribusiness facilities

### CERTIFICATION DATA

#### Classification:

Group II

Category 2GD

#### Installation: EN 60079.14

zone 1 - zone 2 (Gas)

zone 21 - zone 22 (Dust)

#### Marking:

CE 0722 Ex II 2 GD Ex db eb IIC T6/T5/T4 Gb; Ex tb IIIC T80°C Db

#### Certificate:

ATEX [CY 25 ATEX 0207540X](#)

IEC Ex [IECEX CQM 25.0032X](#)

INMETRO [DNV 25.0219X](#)

For all IEC Ex and INMETRO certification data, download the certificate from [www.cortemgroup.com](http://www.cortemgroup.com)

#### Standards:

CENELEC EN and European Directive 2014/34/EU.  
IEC 60079-0: 2017, IEC 60079-1: 2014, IEC 60079-31: 2022, IEC 60079-7:2017  
RoHS Directive 2002/95/EC.

#### Temperature class:

Gas

16A

T6/T5

32A

T5

63A

T5/T4

125A

T4

#### Surface temperature:

Dust

16A, 32A, 63A, 125A

T80°C

#### Amb. Temperature:



-45°C +50°C (+65°C)



(see the table in the certificate)

#### Degree of protection:







IP66



# Series CMBSP07... Sockets and plugs - plastic material

## 4 Outline and Installation Dimension, Wiring Diagram (Dimensions in mm)

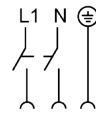





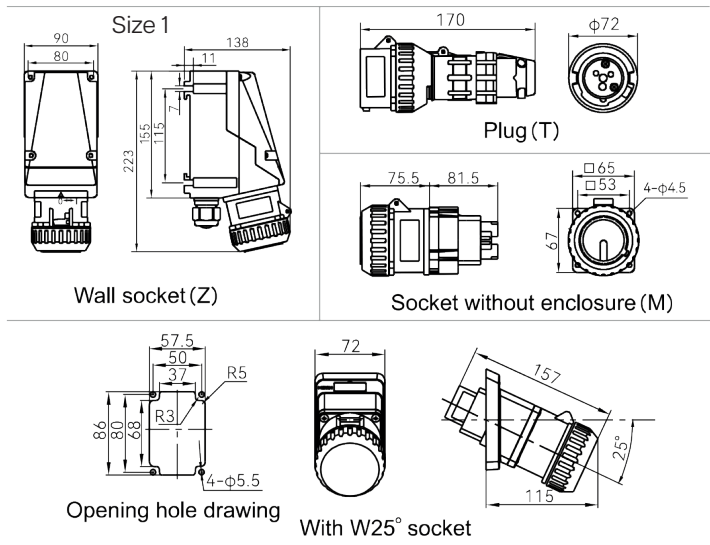

### Product Version (16A/3P)

CMBSP07-16/3	Clock h and voltage
 (Z)	 110~130V 1P+N+PE Yellow
 (T)	 200~250V 1P+N+PE Blue
 (M)	<b>Wiring Diagram (16A/3P)</b>   1P+N+PE

### Outline and Installation Dimension (16A/3P)









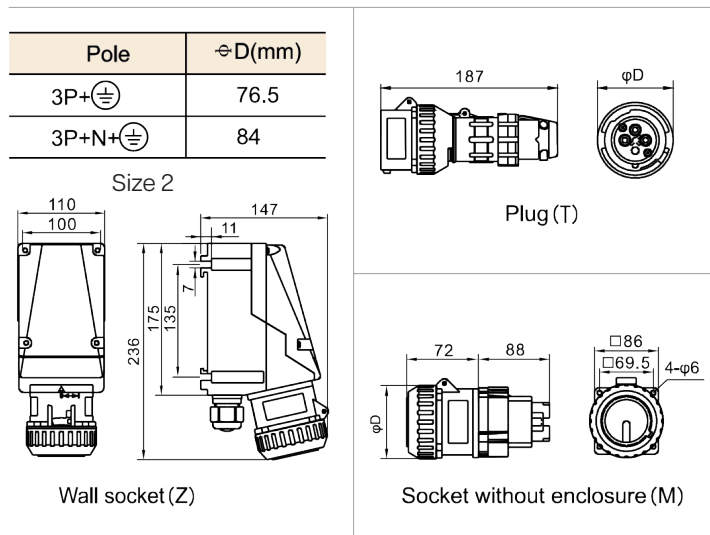

### Product Version (16A/4P)

CMBSP07-16/4	Clock h and voltage
 (Z)	 200~250V 3P+PE Blue
 (T)	 380~415V 3P+PE Red
 (M)	 480~500V 3P+PE Black
 (M)	 600~690V 3P+PE Black

### Outline and Installation Dimension (16A/4(5)P)



### Product Version (16A/5P)





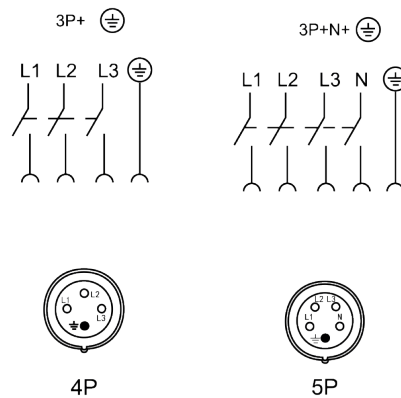





CMBSP07-16/5	Clock h and voltage
 (Z)	 200~250V 3P+N+PE Blue
 (T)	 380~415V 3P+N+PE Red
 (M)	 480~500V 3P+N+PE Black
 (M)	 600~690V 3P+N+PE Black

### Wiring Diagram (16A/4(5)P)













# Series CMBSP07... Sockets and plugs - plastic material

## Product Version (32A/4P)

CMBSP07-32/4	Clock h and voltage
 (Z)	 200~250V  3P+PE Blue
	 380~415V  3P+PE Red
 (T)	 480~500V  3P+PE Black
 (M)	 600~690V  3P+PE Black

## Product Version (32A/5P)

CMBSP07-32/5	Clock h and voltage
 (Z)	 200~250V  3P+N+PE Blue
	 380~415V  3P+N+PE Red
 (T)	 480~500V  3P+N+PE Black
 (M)	 600~690V  3P+N+PE Black

## Outline and Installation Dimension (32A/4(5)P)

Pole	φ D(mm)
2P、2P+⊕	95
3P+⊕	95
3P+N+⊕	100

Size 3

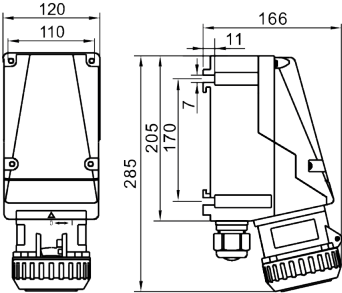

Wall socket (Z)

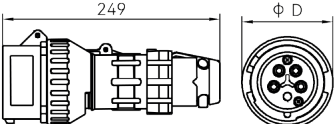

Plug (T)

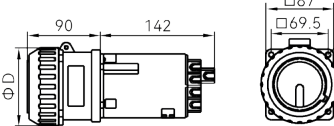

Socket without enclosure (M)

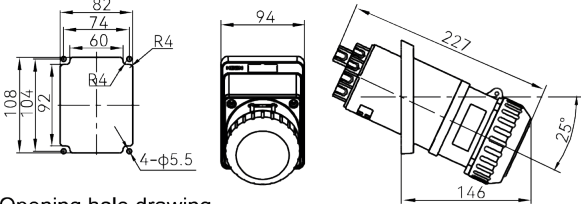

Opening hole drawing  
With W25° socket

Wiring Diagram (32A/4(5)P)

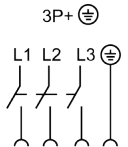

3P+⊕



4P

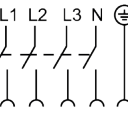









3P+N+⊕











5P

# Series CMBSP07... Sockets and plugs - plastic material

## Product Version (63A/4P)

CMBSPO7-63/4	Clock h and voltage
 <p>Wall socket (Z)</p> <p>Plug (T)</p>	 200~250V  3P+PE Blue h9
	 380~415V  3P+PE Red h6
	 480~500V  3P+PE Black h7
	 600~690V  3P+PE Black h5

## Product Version (63A/5P)

CMBSPO7-63/5	Clock h and voltage
 <p>Wall socket (Z)</p> <p>Plug (T)</p>	 200~250V  3P+N+PE Blue h9
	 380~415V  3P+N+PE Red h6
	 480~500V  3P+N+PE Black h7
	 600~690V  3P+N+PE Black h5



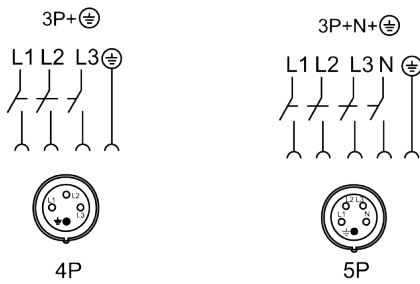



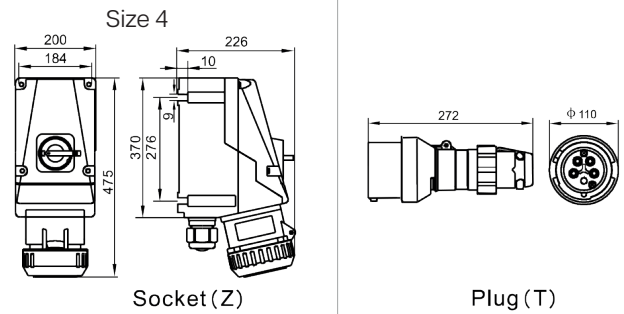



## Wiring Diagram (63A/4(5)P)



## Outline and Installation Dimension (63A/4(5)P)



## Product Version [125A/4(5)P]

CMBSPO7-125/4	Clock h and voltage
 <p>Wall socket (Z)</p> <p>Plug (T)</p>	 220~250V  3P+PE Blue h9
	 380~415V  3P+PE Red h6
	 480~500V  3P+PE Black h7
	 600~690V  3P+PE Black h5
CMBSPO7-125/5	Clock h and voltage
 220/380V  240/450V 3P+N+PE Red h6	

## Wiring Diagram [125A/4(5)P]

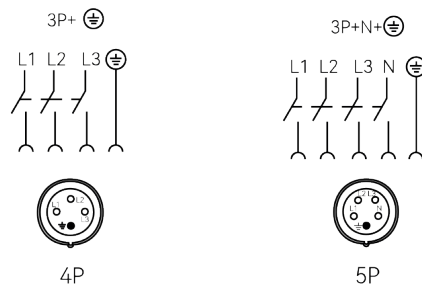

## Outline and Installation Dimension [125A-4(5)P]

