

FLFE..L

FLF..L

- Zone 1, 2, 21, 22
- With LED tubes
- Easy re-lamping
- Designed to last over time

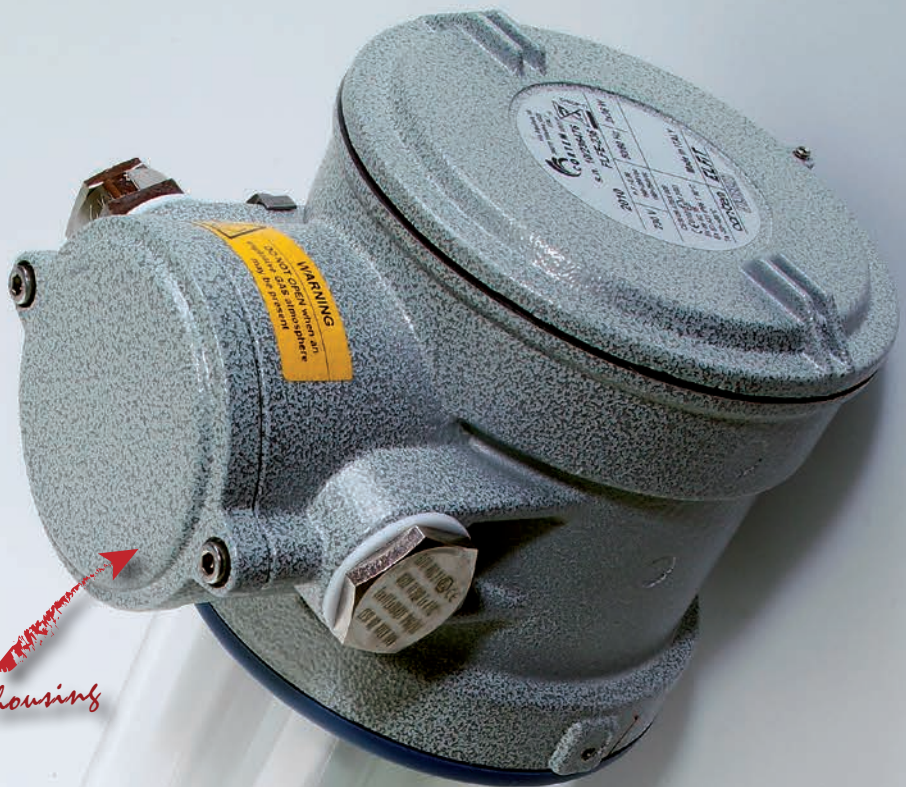

"Ex e" terminal board housing

4 Joule shock resistant borosilicate glass

Simplified maintenance



White painted reflector/frame

Ex d execution type FLF..L



FLFE...L, FLF...L series Lighting fixtures with LED tubes

Lighting fixtures for LED tubes FLFE-...L (Ex de) and FLF-...L (Ex d) series have two low copper content aluminium heads fitted with G13 lamp holder, a tempered borosilicate glass tube that is resistant to changes in heat and a white painted aluminium reflector. The 'Ex de' lighting fixture features an "Ex e" terminal board housing that allows entry to the lamp with a cable gland with an "Ex" seal (normal) as specified in installation standard (EN/IEC 60079.14). The entry to the 'Ex d' lighting fixtures must be through an Ex "barrier" cable gland (sealed) or, in the case of a conduit system, with an EYS, EZS series sealing fittings. The round cross section of the lamp provides a better "Cx" coefficient with less resistance to the wind and less accumulation of dust. For this reason, these units are recommended for use in hazardous places where climatic and environmental conditions are severe and as they require less maintenance thanks to a very high ageing index. As the electrical components are housed on a frame with guides, re-lamping is quick and efficient. The fact that the fixture is fitted with a glass tube as opposed to a plastic material, makes it more effective and with a longer lifespan.

Application sectors:



CERTIFICATION DATA

Classification:	Group II	Category 2GD		
Installation: EN 60079.14	zone 1 - zone 2 (Gas)	zone 21 - zone 22 (Dust)		
Marking:	CE 0722 Ex II 2GD Ex db op is IIC T6 Gb - Ex tb op is IIIC T71÷T80°C Db IP66 (FLF)			
	CE 0722 Ex II 2GD Ex db eb op is II C T6 Gb - Ex tb op is IIIC T71÷T80°C Db IP66 (FLFE)			
Certification:	ATEX CESI 09 ATEX 008			
	IECEX CES 11.0021	All IEC Ex, INMETRO certification data can be downloaded at www.cortemgroup.com		
	INMETRO DNV 12.0159			
Standards:	CENELEC EN 60079-0: 2018, EN 60079-1: 2014, EN 60079-7: 2015/A1: 2018, EN 60079-31: 2014 and EUROPEAN DIRECTIVE 2014/34/UE IEC 60079-0:2004, IEC 60079-1:2007, IEC 60079-7:2006, IEC 61241-0:2004, IEC 61241-1:2004 European Directive 2004/108 Electromagnetic compatibility European Directive 2012/19/UE, 2002/96/CE, 2003/108/CE WEEE European Directive 2011/65/UE RoHS			
Class temperature:	85°C (T6)	85°C (T6)		
Ambient temperature:	Standard -20°C +55°C	With emergency -20°C +50°C		
Degree of protection:	IP66			

FLFE...L, FLF...L series Lighting fixtures with LED tubes



MECHANICAL FEATURES

Body:	Low copper content aluminium alloy heads
External tube:	Shock and high temperature resistant borosilicate glass
Gaskets:	Acid/hydrocarbon resistant NBR on covers
Inner frame:	White painted aluminium that acts as reflector
Bolts and screws:	Stainless steel
Cap chain:	Stainless steel
Mounting:	2 x M8 holes
Entries:	2 x ISO M25 entries for FLFE, fixture kit with PLG2IB plug and NAV25IB cable gland 2 x 3/4" threaded NPT for FLF. Fixture set with 1 x PLG2NA plug
Coating:	Polyester coating Ral 7035 (Light grey)
Corrosion Resistance:	The STANDARD of the aluminium alloy used by Cortem has passed the tests required by standards EN60068-2-30 (hot/humid cycles) and EN60068-2-11 (salt mist tests)



ORIGINAL PRODUCT

ELECTRICAL FEATURES

Lamp holders:	Bi-pin G13
Rated voltage:	220/240 V AC
Rated frequency:	50/60 Hz
LED tubes:	11-22-31 W max.
Connection:	Direct to the terminal board L, N, Pe section 4 mm ² with jumpers suitable for input/output
Power factor:	0,98
Emergency unit:	Electronic inverter 220V/240V, 50/60Hz. Batteries Ni/Cd, 4 Ah o 7 Ah, 6 V
Wiring:	Silicone rubber cables with glass braid insulation for high temperatures
Safety:	Internal safety switch installed for emergency lighting fixtures

NOTE: The technical and electrical specifications may be changed without notice due to continuous developments of LED technology.

ACCESSORIES AVAILABLE / SPECIAL REQUESTS

Different rated voltages
Installation mounting brackets
Stainless steel or galvanized steel guard with external aluminium protection
External aluminium protection recommended for outdoor installations
Re-lamping bracket for use on in-line lighting fixtures
Cable gland: NEVB2NB for armoured cable or NAVB2NB for non-armoured cable (only for FLF...L)
Lighting fixture with separate emergency battery pack for temperatures of -20°C to +55°C (code FLFE-222EF7E)
Cable entry: 2 x ISO M20 holes. Lighting fixture with 1 model PLG1IB plugs and 1 model NAV20SIB cable glands for non-armoured cable (code FLFE-111LEF4/20)

FLFE...L, FLF...L series Lighting fixtures with LED tubes

Ex de lighting fixtures

Code	Dimensions mm				LED tubes n°	Power supply	Lumen*	Watt*	Weight kg	mm
	A	A1	B	C						
FLFE-111L	725	640	142	197	1	220/240 Vac	925	11	5,0	240x230x800
FLFE-211L	725	640	142	197	2	220/240 Vac	1850	11	5,0	240x230x800
FLFE-122L	1325	1240	142	197	1	220/240 Vac	2150	22	7,8	240x230x1410
FLFE-222L	1325	1240	142	197	2	220/240 Vac	4300	22	7,8	240x230x1410
FLFE-131L	1625	1540	142	197	1	220/240 Vac	2700	31	9,5	240x230x1700
FLFE-231L	1625	1540	142	197	2	220/240 Vac	5400	31	9,5	240x230x1700

* Indicative information depending on the installed tube

DIMENSIONAL DRAWING

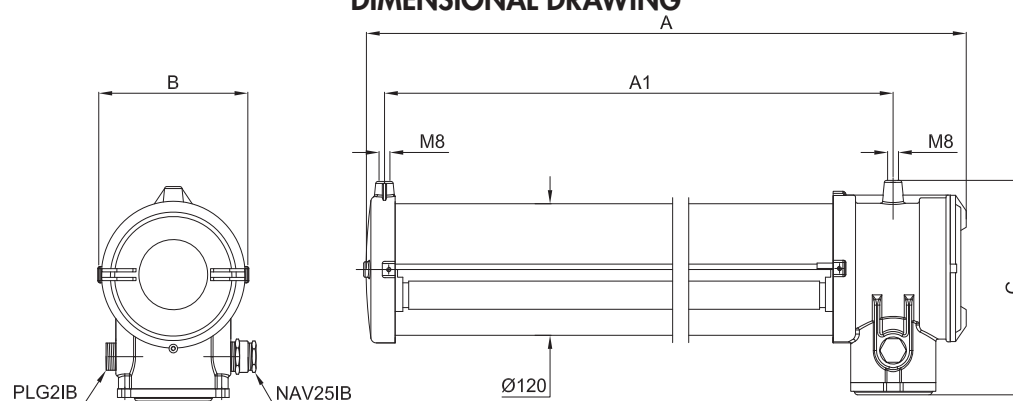

Ex d lighting fixtures

Code	Dimensions mm				LED tubes n°	Power supply	Lumen*	Watt*	Weight kg	mm
	A	A1	B	C						
FLF-111L	725	640	142	145	1	220/240 Vac	925	11	4,5	240x230x800
FLF-211L	725	640	142	145	2	220/240 Vac	1850	11	4,5	240x230x800
FLF-122L	1325	1240	142	145	1	220/240 Vac	2150	22	7,3	240x230x1410
FLF-222L	1325	1240	142	145	2	220/240 Vac	4300	22	7,3	240x230x1410
FLF-131L	1625	1540	142	145	1	220/240 Vac	2700	31	9,0	240x230x1700
FLF-231L	1625	1540	142	145	2	220/240 Vac	5400	31	9,0	240x230x1700

* Indicative information depending on the installed tube

DIMENSIONAL DRAWING

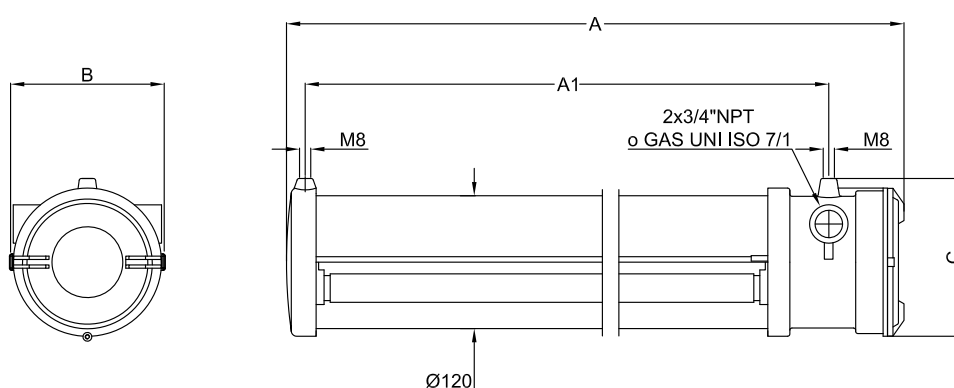

FLFE...L, FLF...L series Lighting fixtures with LED tubes

Lighting fixtures Ex de with emergency unit

Code	Dimension mm				Operating type	N° of Lamp	Power supply	Lumen* (in emergency)	Watt*	Discharge time in minutes	Weight kg	mm
	A	A1	B	C								
FLFE-111LEF4	725	640	142	197	normal+emergency	1	220/240 Vac	946	11	90	5,0	240x230x800
FLFE-211LEF4	725	640	142	197	normal+emergency	2	220/240 Vac	946	11	90	5,0	240x230x800
FLFE-122LEF4	1325	1240	142	197	normal+emergency	1	220/240 Vac	1731	22	40	7,8	240x230x1410
FLFE-222LEF4	1325	1240	142	197	normal+emergency	2	220/240 Vac	1731	22	40	7,8	240x230x1410
FLFE-111LEE4	725	640	142	197	only emergency	1	220/240 Vac	946	11	90	5,0	240x230x800
FLFE-122LEE4	1325	1240	142	197	only emergency	1	220/240 Vac	1731	22	40	7,8	240x230x1410
FLFE-111LEF7	725	640	142	197	normal+emergency	1	220/240 Vac	960	11	120	5,0	240x230x800
FLFE-211LEF7	725	640	142	197	normal+emergency	2	220/240 Vac	960	11	120	5,0	240x230x800
FLFE-122LEF7	1325	1240	142	197	normal+emergency	1	220/240 Vac	1757	22	60	7,8	240x230x1410
FLFE-222LEF7	1325	1240	142	197	normal+emergency	2	220/240 Vac	1757	22	60	7,8	240x230x1410
FLFE-111LEE7	725	640	142	197	only emergency	1	220/240 Vac	960	11	120	5,0	240x230x800
FLFE-122LEE7	1325	1240	142	197	only emergency	1	220/240 Vac	1757	22	60	7,8	240x230x1410

* Indicative information depending on the installed tube

DIMENSIONAL DRAWINGS

Dimensions in mm

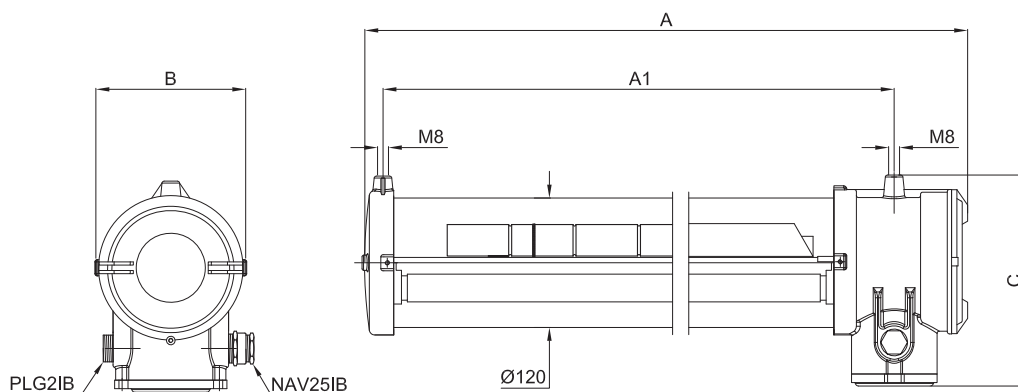

FLFE...L, FLF...L series Lighting fixtures with LED tubes

Lighting fixtures Ex d with emergency unit

Codice	Dimension mm				Operating type	N° of Lamp	Power supply	Lumen* (in emergency)	Watt*	Discharge time in minutes	Weight kg	 mm
	A	A1	B	C								
FLF-111LEF4	725	640	142	145	normal+emergency	1	220/240 Vac	946	11	90	5,0	240x230x800
FLF-211LEF4	725	640	142	145	normal+emergency	2	220/240 Vac	946	11	90	5,0	240x230x800
FLF-122LEF4	1325	1240	142	145	normal+emergency	1	220/240 Vac	1731	22	40	7,8	240x230x1410
FLF-222LEF4	1325	1240	142	145	normal+emergency	2	220/240 Vac	1731	22	40	7,8	240x230x1410
FLF-111LEE4	725	640	142	145	only emergency	1	220/240 Vac	946	11	90	5,0	240x230x800
FLF-122LEE4	1325	1240	142	145	only emergency	1	220/240 Vac	1731	22	40	7,8	240x230x1410
FLF-111LEF7	725	640	142	145	normal+emergency	1	220/240 Vac	960	11	120	5,0	240x230x800
FLF-211LEF7	725	640	142	145	normal+emergency	2	220/240 Vac	960	11	120	5,0	240x230x800
FLF-122LEF7	1325	1240	142	145	normal+emergency	1	220/240 Vac	1757	22	60	7,8	240x230x1410
FLF-222LEF7	1325	1240	142	145	normal+emergency	2	220/240 Vac	1757	22	60	7,8	240x230x1410
FLF-111LEE7	725	640	142	145	only emergency	1	220/240 Vac	960	11	120	5,0	240x230x800
FLF-122LEE7	1325	1240	142	145	only emergency	1	220/240 Vac	1757	22	60	7,8	240x230x1410







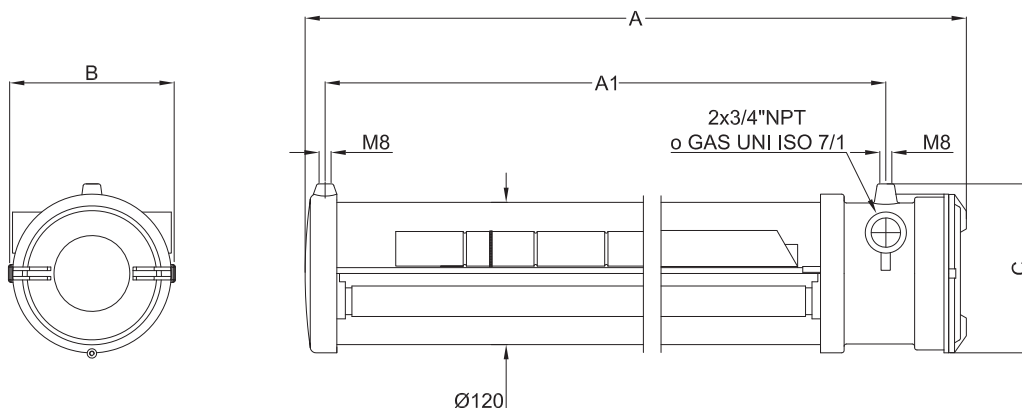











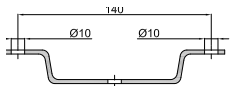

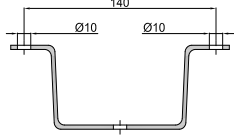

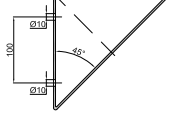

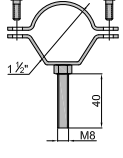

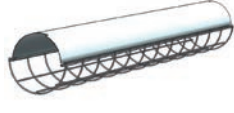





* Indicative information depending on the installed tube

DIMENSIONAL DRAWINGS

Dimensions in mm



FLFE...L, FLF...L series Accessories and spare parts available

ILLUSTRATION	DESCRIPTION	MODEL	FEATURES	CODE	KEY
	LED tubes G13 fitting	11 W Max. 22 W Max. 31 W Max.	Contact our Sales Office for availability		 
	Tige	Longitud: 250 mm	Material: stainless steel	BRF8MIN/250	 
	Type O eyebolt		Material: galvanised steel	GOF-8	 
	Type U bracket complete with screws		Material: bracket: galvanised steel screws: stainless steel	G-0609	 
	Type V bracket complete with screws		Material: bracket: galvanised steel screws: stainless steel	G-0610	 
	Type D bracket complete with screws		Material: bracket: galvanised steel screws: stainless steel	G-0611	 
	Type P bracket		Material: galvanised steel	G-0480	 
	Guard with Light blue/white painted 10/10 aluminium external protection	11 W	Stainless steel guard	G18-0529	 
		22 W		G36-0529	
		31 W		G58-0529	
		11 W	Galvanised steel guard	G18-0529G	
		22 W		G36-0529G	
		31 W		G58-0529G	
	External protection	11 W	Light blue/white painted 10/10 aluminium external protection	G18-568	 
		22 W		G36-568	
		31 W		G58-568	
		11 W	10/10 stainless steel AISI 304 external protection	G18-568IN	
		22 W		G36-568IN	
		31 W		G58-568IN	
	Cable gland	FLF...L	For models and codes, visit www.cortemgroup.com	NAVB2NB NEVB2NB	 
	Lamp holder	FLF...-1..L	G13 250 V, 4 A	STU3249-12/S	
		FLF...-2..L			
	Inverter		110/230 V 50/60 Hz	03240E205I/240	
	Battery pack		4Ah 6V NiCd	BATT4AH/D	
			7Ah 6V NiCd	BATT7AH/D	
	Re-lamping bracket with clip system for use on in-line lighting fixtures		Material: galvanised steel	G-0318 + G-0318/1	 

Installation and mounting methods and photometric diagrams

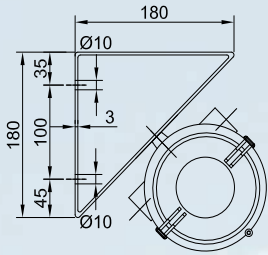

45° angle mounting
TYPE "D"

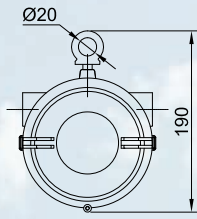

Pendant mounting with
eyebolt TYPE "O"

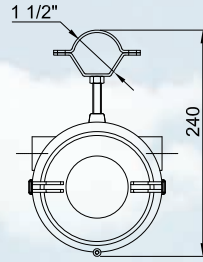

Mounting using 1.1/2"
metal clamps TYPE "P"

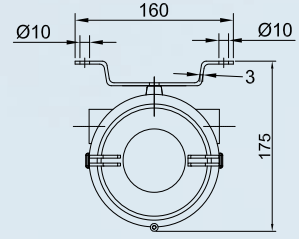

Low ceiling mounting with
clamp TYPE "U"

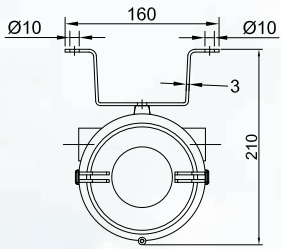

High ceiling mounting with
clamp TYPE "V"

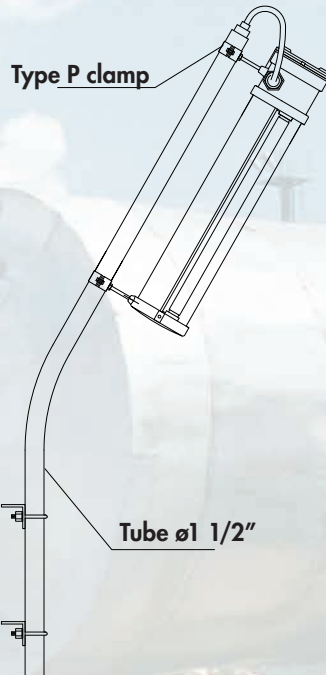

Pole mounting for FLF...L
with barrier cable gland

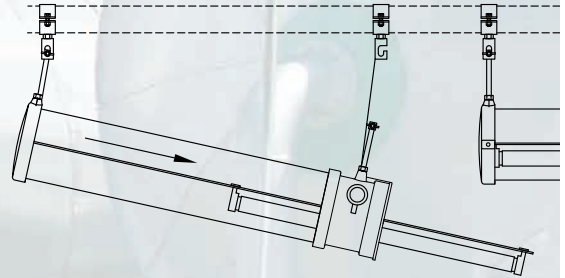
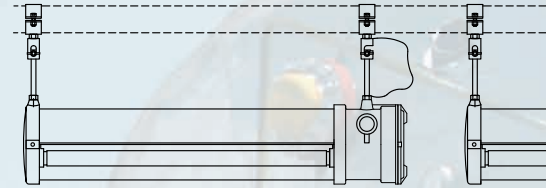

Mounting system with quick release clip for easy
fluorescent tube replacement. System suitable for
installing in-line lighting fixtures.

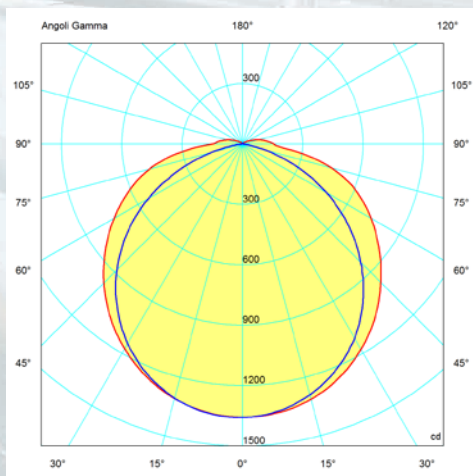

FLFE-222L / FLF-222L

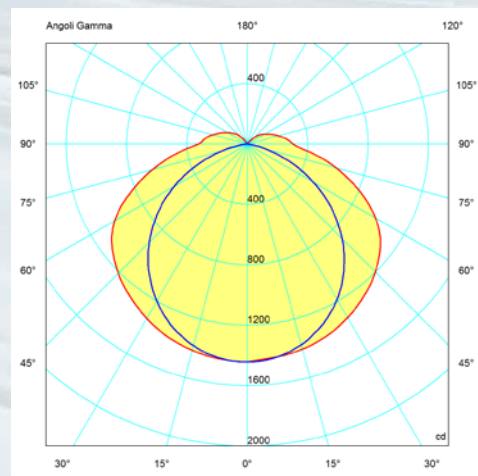

FLFE-231L / FLF-231L

On Cortem Group web site you can download .LDT and .IES lighting data files for the design and simulation of lighting levels in 2D and 3D, rendering and ray tracing.

— = plane 90270
— = plane 0180