

EXEL

- Double locking system operated by hexagonal-head tool
- Double channel electronic ballast
- Zones 1, 2, 21, 22



Reinforced polyester resin body

G13 bi-pin lamp holder



Internal emergency batteries



Reinforced locking system



Transparent polycarbonate cover

EXEL series Lighting fixtures for fluorescent tubes

EXEL series increased safety bi-pin fluorescent lighting fixture have a Cortem electronic ballast system that complies with Atex Directive 2014/34/UE. They can be installed in hazardous zones 1, 2, 21 and 22 where a high degree of protection and resistance against corrosion is required such as in chemical and petrochemical plants, off-shore and on-shore plants, processing areas in food industries etc... Fluorescent tubes that reach the end of their working lives are safely monitored and switched off by means of the EOL (End-Of-Life) system. The fact that they have different voltage ratings means they can be used worldwide. Thanks to the double channel ballast design, if one of the tubes stops working, the other continues working independently. As cable entries/exits are fitted to both sides of the fixture body, installation is simple and fast. The transparent cover is clipped into place on both sides of the fixture body with 8 clips on the 18W and 14 on the 36W unit. This ensures excellent protection against dust and water over time despite any degradation caused by ageing. For this very reason, these units are often installed in water purification plants and in areas that are hazardous for ships and ferries. A safety switch is housed inside the fixture that automatically cuts off the power supply when the fixture is opened to replace a fluorescent tube and/or an electrical component. EXEL...E series is fitted with a Ni-Cd battery and electronic inverter for use in emergency operation. The operating time under emergency operation of the single fluorescent tube can be selected depending on requirements and can last from a minimum of 90 minutes to a maximum of 200 minutes. A red LED warning light comes off if the battery needs to be replaced due to a short circuit or if the battery itself is dead.

Application sectors:

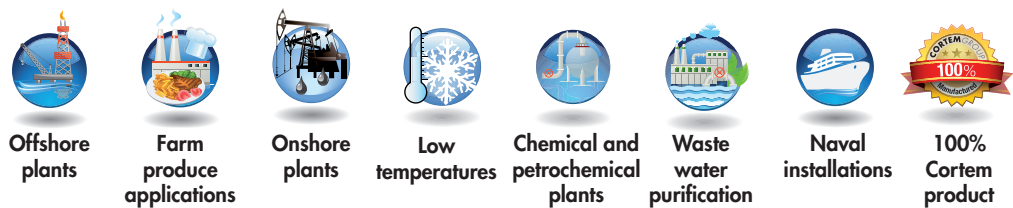

CERTIFICATION DATA

Classification:	Group II	Category 2GD		
Installation: EN 60079.14	zone 1 - zone 2 (Gas)	zone 21 - zone 22 (Dust)		
Marking:	CE 0722 Ex II 2GD - Ex de mb IIC T4 Gb - Ex tb IIIC T70°C, T80°C Db IP66 (*)			
	CE 0722 Ex II 2GD Ex de IIC T4 Gb - Ex tb IIIC T70°C, T80°C Db IP66 (**)			
	(*) Marking valid for lighting fixtures with operating type normal and normal + emergency. (**) Marking valid only for lighting fixtures with operating type emergency and emergency with batteries housed in separate box.			
Certification:	ATEX CESI 03 ATEX 074			
	IEC Ex CES 07.0001	All IEC Ex and INMETRO certification data can be downloaded at www.cortemgroup.com		
	INMETRO DNV 12.0055 X			
Standards:	CENELEC EN60079-0: 2012, EN60079-1: 2007, EN60079-7: 2007, EN60079-31: 2014, EN61000-3-2, EN 55022, EN60598-1:2008, EN60598-2-22, EN 60529: 1991 and DIRETTIVA EUROPEA 2014/34/UE. IEC60079-0:2011, IEC60079-1:2007, IEC60079-7:2006-07, IEC60079-18:2009, IEC60079-31:2013 European Directive 2004/108 Electromagnetic compatibility European Directive 2012/19/UE, 2002/96/CE, 2003/108/CE WEEE European Directive 2011/65/UE RoHS			
Ambient temperature:	Normal operation -40°C +55°C (T4)	Emergency operation -20°C +50°C (T4)	Separate emergency -20°C +55°C (T4)	
Degree of protection:	IP66			

EXEL series Lighting fixtures for fluorescent tubes



ORIGINAL PRODUCT

MECHANICAL FEATURES

Body:	Black shock and UV resistant fibreglass reinforced anti-static polyester resin
Diffuser:	Transparent polycarbonate, shock and UV resistant
Protected opening system:	Sliding system operated by a hexagonal-head tool (for safety reasons, the fixture can not be opened without the tool)
Gasket:	Acid/hydrocarbon resistant expanded silicone
Internal reflector:	White painted aluminium
Inner frame:	Extruded aluminium
Bolts and screws:	Stainless steel
Entries:	4 x Ø25.5 entries (suitable for ISO M25x1.5 threads). Lighting fixture kit contains 3 model PLG21LXE7 plugs and 2 model NAVP25IXE-X6DS cable glands for non-armoured cable
Mounting:	Nickel plated brass inserts with 2 x M8 holes

ELECTRICAL FEATURES

Lamp holder:	Bi-pin G13
Ballast:	Double channel electronic with EOL protection
Rated voltage:	110/240 Vac/dc
Rated frequency:	50/60 Hz
Connection:	Directly to terminal board L, N, Pe section 4 mm ² terminal board with jumpers suitable for input/output from either side
Power factor:	0.97
Emergency unit:	Electronic inverter 110V/240V, 50/60Hz. Batteries Ni/Cd, 4 Ah or 7 Ah, 6 V Battery charging monitored by high luminosity red LED (estimated LED lifespan 50,000 hours)
Safety:	Internal "Ex de" safety switch
Wiring:	Silicone rubber cables with glass braid insulation for high temperatures

ACCESSORIES AVAILABLE / SPECIAL REQUESTS

2 pin Ø26 fluorescent tubes model T8

Installation brackets

Grey polyester resin body (code EXEL-118EE4G)

Cable entry: 4 x Ø20.5 holes. Lighting fixture kit contains 3 model PLG11LXE7 plugs and 2 model NAVP20IXE cable glands for non-armoured cable (code EXEL-118EE4/20)

Earthing continuity plates for metal cable glands

Close up of EXEL series lighting fixtures



Certified lamp holder made at PBT reinforced polyester. G13 bi-pin fitting

Removable internal reflector

Certified NiCd 6V batteries connected in series for emergency lighting. Can be either 4 or 7Ah units housed in polyethylene box

Certified electronic inverter housed in cylindrical aluminium box with one end sealed to allow passage of cables

Certified electronic ballast EBV with the electronic part housed in an insulating enclosure completely incorporated in resin. Manufactured with electronic circuit made to match the requirements regarding the lamp's End Of Life (EOL) protection; provided with protections to prevent over heating of the lamps at end of life

Safety switch

Terminal board section 4mm²

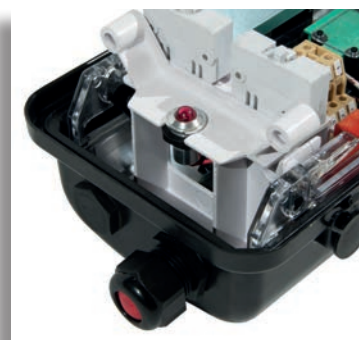
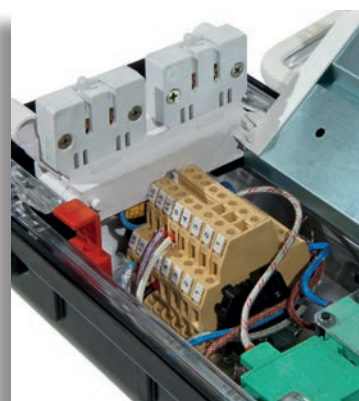
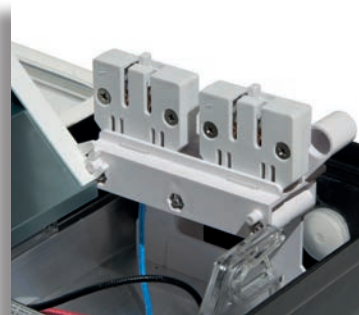

EXEL series selection chart

Single and double tube

Code	Dimensions mm				Type of ballast	N° of lamps	Power supply	Watt	Weight kg	 mm
	A	A1	B	C						
EXEL-118	785	420	185	155	electronic	1	110/240 V 50/60 Hz.	18	5,2	195x155x820
EXEL-136	1370	720	185	155	electronic	1	110/240 V 50/60 Hz.	36	7,9	196x155x1400
EXEL-218	785	420	185	155	electronic double channel	2	110/240 V 50/60 Hz.	18	5,3	196x155x820
EXEL-236	1370	720	185	155	electronic double channel	2	110/240 V 50/60 Hz.	36	7,9	196x155x1400

Single and double tube with emergency unit

Code	Dimensions mm				Operating type	N° of lamps	Power supply	Discharge time in minutes	Watt	Weight kg	 mm
	A	A1	B	C							
EXEL-118EF4	785	420	185	155	normal + emergency	1	110/240 V 50/60 Hz.	120'	18	6,9	196x155x820
EXEL-136EF4	1370	720	185	155	normal + emergency	1	110/240 V 50/60 Hz.	90'	36	10,0	196x155x1400
EXEL-218EF4	785	420	185	155	normal + emergency	2	110/240 V 50/60 Hz.	120'	18	7,05	196x155x820
EXEL-236EF4	1370	720	185	155	normal + emergency	2	110/240 V 50/60 Hz.	90'	36	9,61	196x155x1400
EXEL-118EE4	785	420	185	155	emergency only	1	110/240 V 50/60 Hz.	120'	18	5,62	196x155x820
EXEL-136EE4	1370	720	185	155	emergency only	1	110/240 V 50/60 Hz.	90'	36	8,27	196x155x1400
EXEL-118EF7	785	420	185	155	normal + emergency	1	110/240 V 50/60 Hz.	200'	18	7,60	196x155x820
EXEL-136EF7	1370	720	185	155	normal + emergency	1	110/240 V 50/60 Hz.	180'	36	10,0	196x155x1400
EXEL-218EF7	785	420	185	155	normal + emergency	2	110/240 V 50/60 Hz.	200'	18	7,40	196x155x820
EXEL-236EF7	1370	720	185	155	normal + emergency	2	110/240 V 50/60 Hz.	180'	36	10,2	196x155x1400
EXEL-118EE7	785	420	185	155	emergency only	1	110/240 V 50/60 Hz.	200'	18	6,00	196x155x820
EXEL-136EE7	1370	720	185	155	emergency only	1	110/240 V 50/60 Hz.	180'	36	8,60	196x155x1400

DON'T FORGET TO ORDER THE ACCESSORIES

Example: Type of lighting fixture,
EXEL-118EF4

Fluorescent tubes
LAMPL18W21

+

Installation fittings
G-244

+ other...see key



EXEL series selection chart

Single and double lamp units with separate emergency battery pack for temperatures of -20°C to + 55°C

Code	Dimensios mm				Operating type	N° of lamps	Power supply	Discharge time in minutes	Watt	Weight kg	mm
	A	A1	B	C							
EXEL-118EF4E	785	420	185	155	normal + emergency	1	110/240 V 50/60 Hz.	120'	18	7,80	200x170x950
EXEL-136EF4E	1370	720	185	155	normal + emergency	1	110/240 V 50/60 Hz.	90'	36	11,0	200x170x1550
EXEL-218EF4E	785	420	185	155	normal + emergency	2	110/240 V 50/60 Hz.	120'	18	8,00	200x170x950
EXEL-236EF4E	1370	720	185	155	normal + emergency	2	110/240 V 50/60 Hz.	90'	36	10,7	200x170x1550
EXEL-118EE4E	785	420	185	155	emergency only	1	110/240 V 50/60 Hz.	120'	18	6,50	200x170x950
EXEL-136EE4E	1370	720	185	155	emergency only	1	110/240 V 50/60 Hz.	90'	36	9,20	200x170x1550
EXEL-118EF7E	785	420	185	155	normal + emergency	1	110/240 V 50/60 Hz.	200'	18	8,50	200x170x950
EXEL-136EF7E	1370	720	185	155	normal + emergency	1	110/240 V 50/60 Hz.	180'	36	10,9	200x170x1550
EXEL-218EF7E	785	420	185	155	normal + emergency	2	110/240 V 50/60 Hz.	200'	18	8,50	200x170x950
EXEL-236EF7E	1370	720	185	155	normal + emergency	2	110/240 V 50/60 Hz.	180'	36	11,1	200x170x1550
EXEL-118EE7E	785	420	185	155	emergency only	1	110/240 V 50/60 Hz.	200'	18	7,00	200x170x950
EXEL-136EE7E	1370	720	185	155	emergency only	1	110/240 V 50/60 Hz.	180'	36	12,4	200x170x1550

DIMENSIONAL DRAWINGS

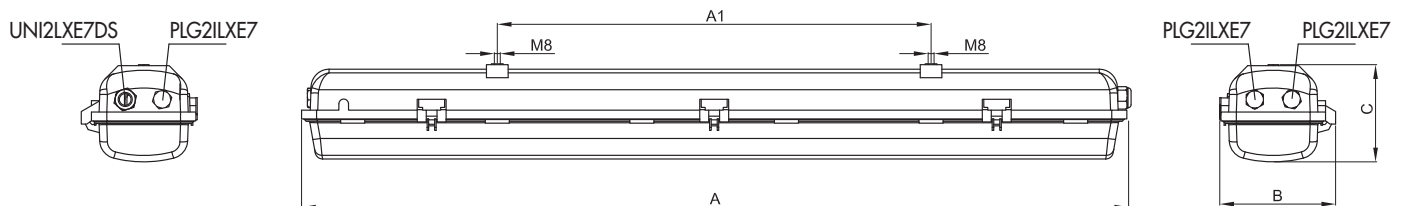

Emergency lamp for temperatures of -20°C + 55°C

Batteries contained in a separate pack type SA141410/P in polyester resin.

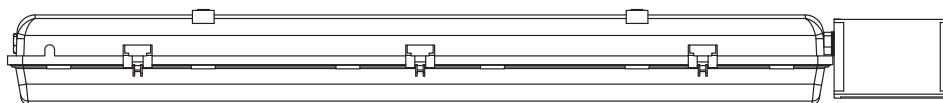
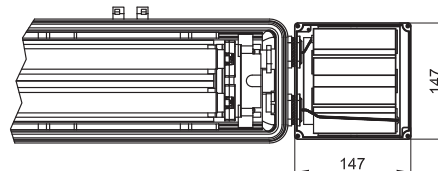



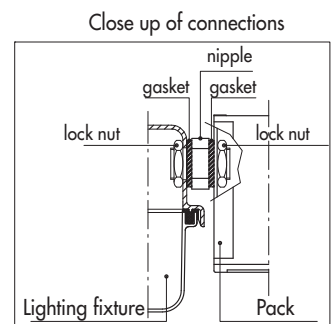











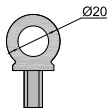

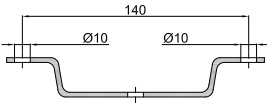

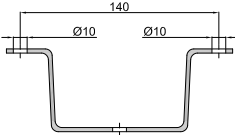

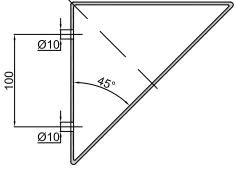

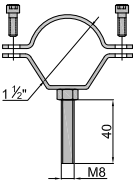
Protección externa SA141410/P en resina de poliéster



Dimensions in mm

EXEL series Accessories and spare parts available on request

ILLUSTRATION	DESCRIPTION	MODEL	FEATURES	CODE	KEY
	Tri-phosphor fluorescent tubes G13 fitting 3.000 K	18 W	1350 lm (FD18W)	LAMPL18W21	 
		36 W	3350 lm (FD36W)	LAMPL36W21	
	Tige	Lunghezza: 250 mm	Material: stainless steel	BRF8MIN/250	 
	Eye bolt		Material: galvanised steel	GOF-8	 
	Type U bracket complete with screws		Material: bracket: galvanised steel screws: stainless steel	G-0609	 
	Type V bracket complete with screws		Material: bracket: galvanised steel screws: stainless steel	G-0610	 
	Type D bracket complete with screws		Material: bracket: galvanised steel screws: stainless steel	G-0611	 
	Type P bracket		Material: galvanised steel	G-0480	 
	Earthing continuity plates for metal cable glands	Holes: M25x1.5	Material: brass	B-479	
		Holes: M20x1.5		B-479/1	
	Non-armoured cable gland complete with rubbers, seal and lock nut	ISO M25x1,5	Ex e II IP 66/67 (std. range cavo 10÷18)	NAVP25IXE-X6DS	
	Plug with seal and lock nut	ISO M25x1,5	Ex e II IP 66/67	PLG2ILXE7	

EXEL series Accessories and spare parts available on request

ILLUSTRATION	DESCRIPTION	MODEL	FEATURES	CODE	KEY
	Transparent diffuser	18 W	Material: polycarbonate	B18-363	
		36 W		B36-363	
	Standard Reflector	18 W	Material: white plastic coated aluminium	B18-0213	
		36 W		B36-0213	
	Safety switch: Ex de	18 W 36 W	2 for normal lamps 4 for emergency lamps	M-0530/A	
		solo per 36 W EF	2 pz M-0530/A + 2 pz M-0530	M-0530/A + M-0530	
	Inverter fixing bracket		Material: nylon	B-380	
	Hexagonal-head tool	Hexagon 10		CLAFT10	
	Electronic inverter		110/240 V 50/60 Hz	EI-58	
	Battery pack		4 Ah 6V NiCd	G-0309B	
			7 Ah 6V NiCd	G-0309	
 	Lamp holder	G13	320 V - 2 A	G-0598	
 	Lamp holder	G13	250 V - 4 A	G-0312E/...	
	Double channel electronic ballast	1 x 18 W	110/240 V 50/60 Hz	EB4118/M	
		2 x 18 W		EB4218/M	
		1 x 36 W		EB4136/M	
		2 x 36 W		EB4236/M	
	Double channel resin-bonded electronic ballast	1 x 18 W 2 x 18 W 1 x 36 W 2 x 36 W	110/240 Vac/dc 0/50/60 Hz	EBV-1	

Installation and mounting methods EXEL series

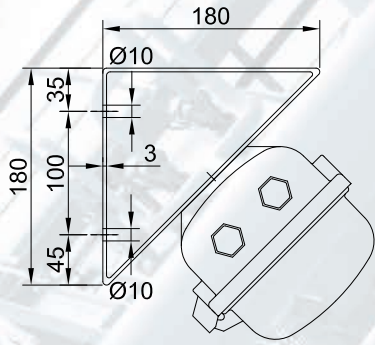

45° angle mounting
TYPE "D"

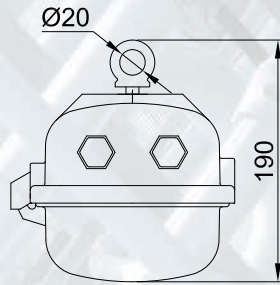

Pendant mounting
with eyebolt TYPE "O"

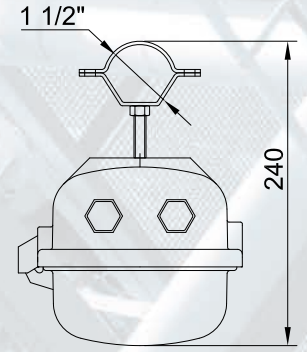

Mounting using 1.1/2"
metal clamps TYPE "P"

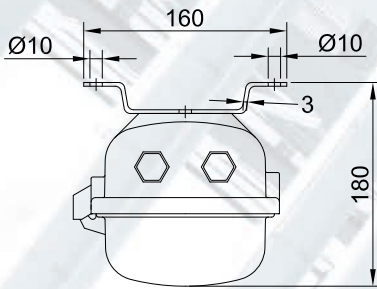

Low ceiling mounting with
clamp TYPE "U"

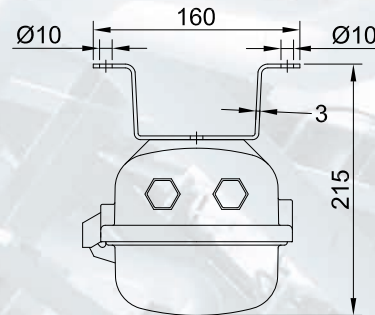

High ceiling mounting with
clamp TYPE "V"

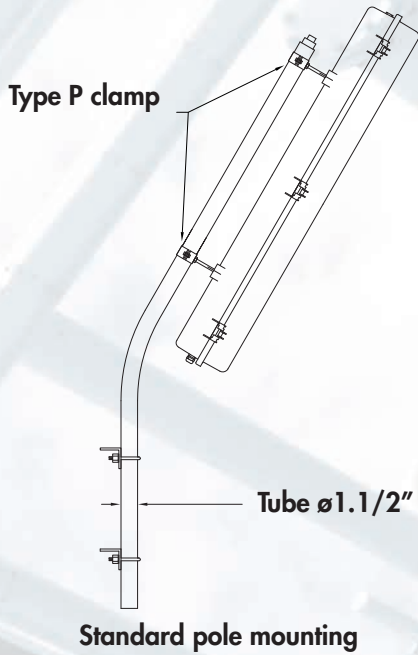

Standard pole mounting

Wiring diagrams

Normal lighting fixture

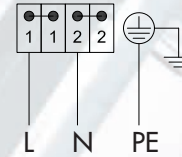

Power supply

Lighting fixture with emergency system

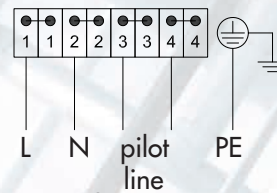

Power supply

Connections can be made on either side of the fixture body
for simple, fast installation

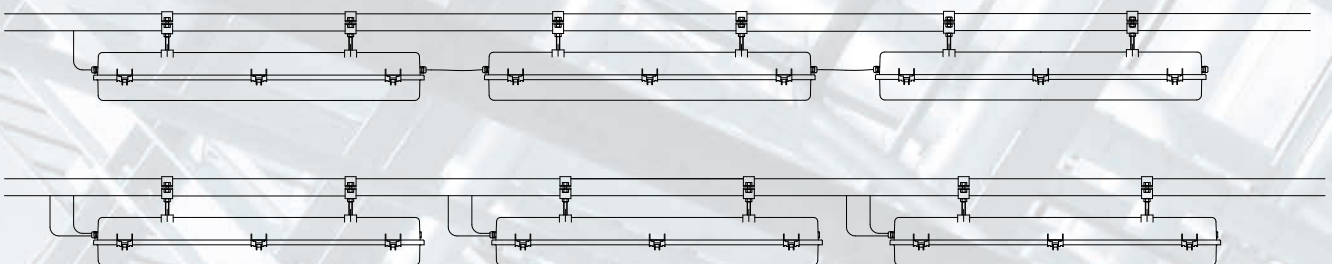

Photometric diagrams

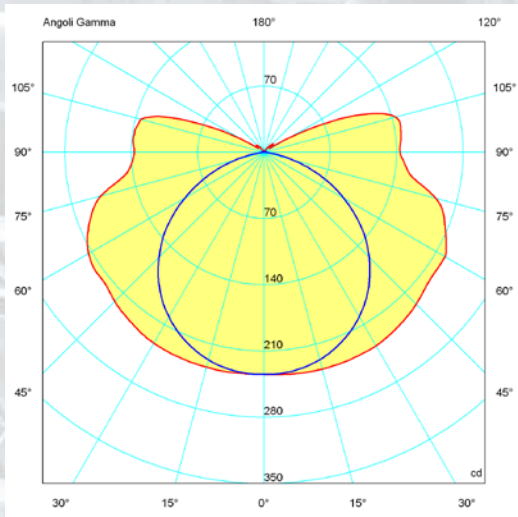

EXEL-118

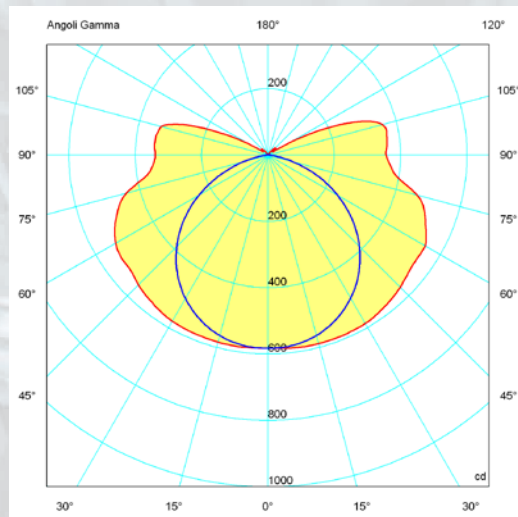

EXEL-136

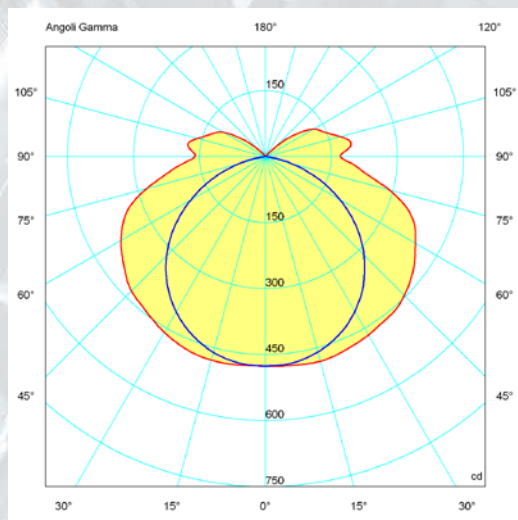

EXEL-218

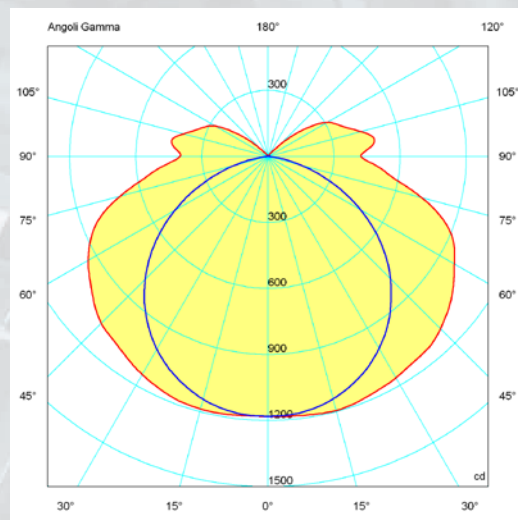

EXEL-236

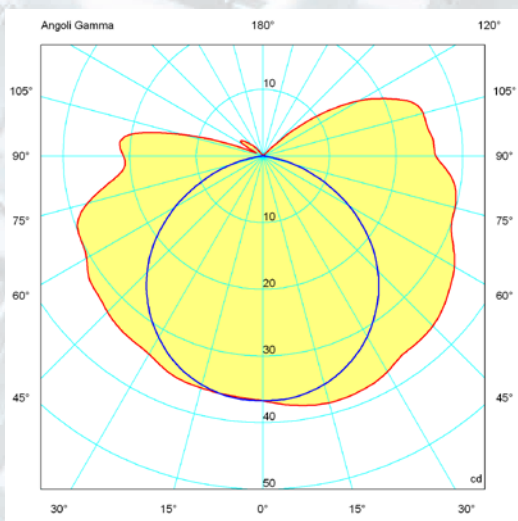

EXEL-218EF4

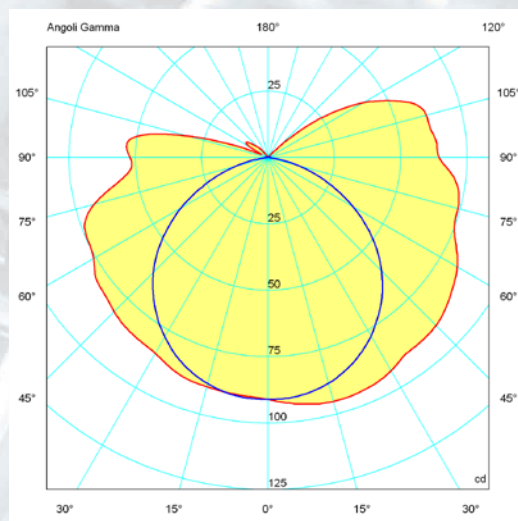

EXEL-236EF4

On Cortem Group web site you can download .LDT and .IES lighting data files for the design and simulation of lighting levels in 2D and 3D, rendering and ray tracing.

— = plane 90270
— = plane 0180