

CTBE

- Zone 1, 2, 21, 22
- Electropolished AISI316L stainless steel junction boxes
- 19 different sizes
- Gasket resistant to acids and high temperatures
- IP66

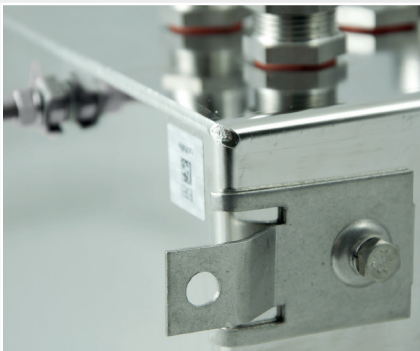

Fixing detail

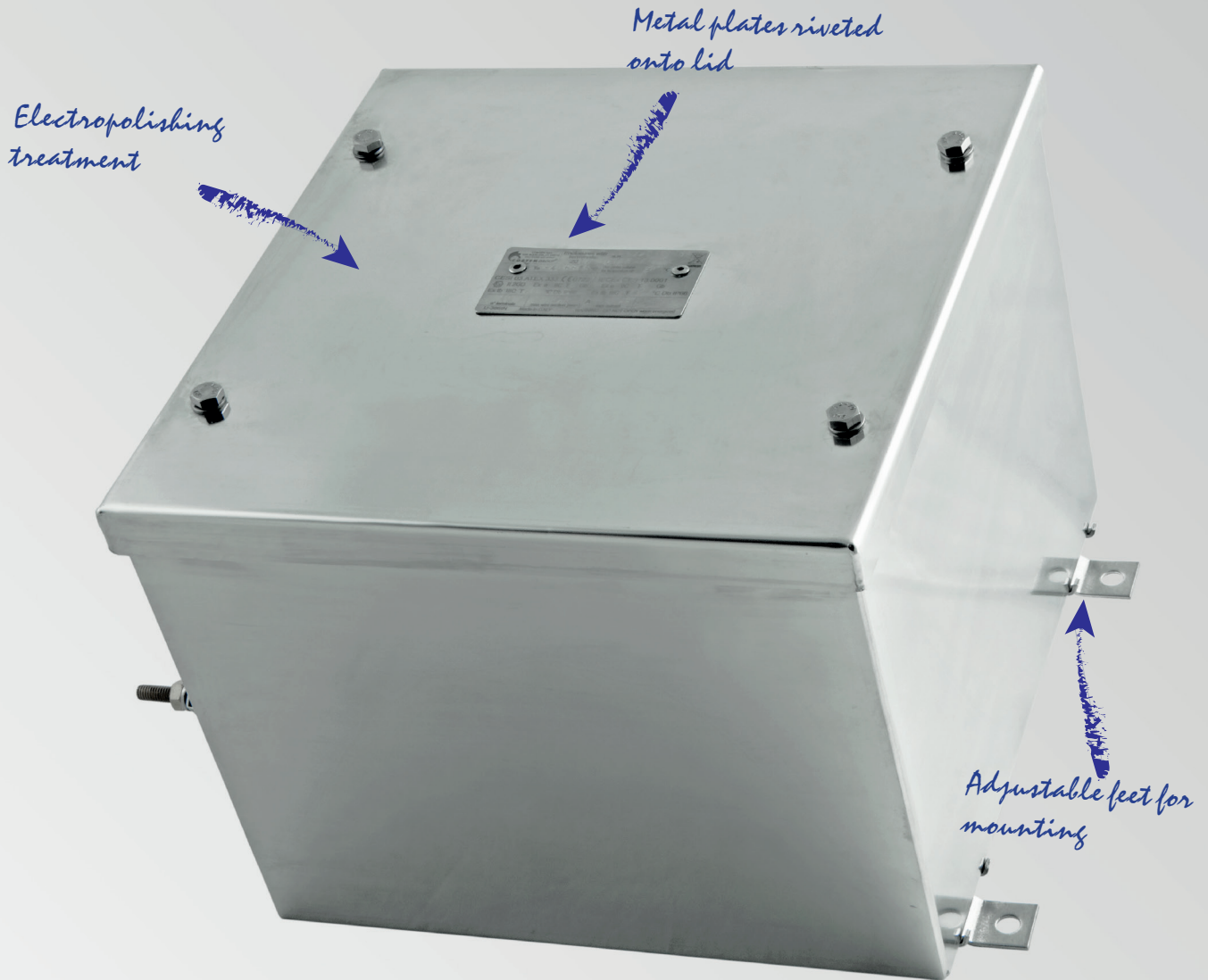

Earth stud with cable anti-rotation bracket

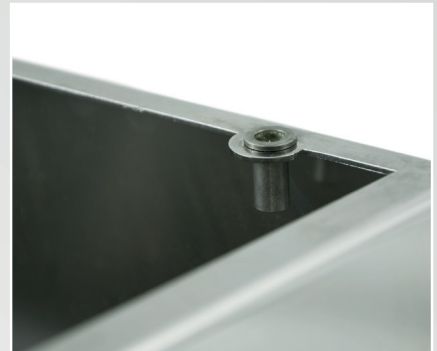

Hinges detail

CTBE... series (Ex e) and (Ex i) stainless steel junction boxes

After carefully analysing the value of the existing CTB enclosure product line and taking into account the two cornerstones of any product: cost and innovation, the product manager at Cortem has re-examined the existing solution and come up with a new range of structurally simpler enclosures, made from stainless steel. The aim was to simplify and streamline installation of these increased-safety or intrinsically safe enclosures in an electrical system. Our ongoing commitment to improving cost efficiency, speed, reliability and quality gradually and simultaneously across the full production chain means that we are delivering new products which are increasingly competitive, innovative and in line with the most precise, targeted requests from the oil and gas market.

Our range of simplified CTBE enclosures are made from AISI 316L stainless steel sheet metal to ensure that they perform in the aggressive environments in which they are installed. These enclosures can be used in industrial plants where there is a risk of explosion and fire, classified as zone 1, 2, 21 or 22. They are mainly used as junction boxes or for routing cables for analogue or digital signals. The main purpose of these enclosures is to protect the components inside from external agents, such as moisture or dust, meaning they must have a suitable IP rating. Cortem tests its enclosures according to standard EN 60529 at its own accredited facilities to ensure that this requirement is met. Cortem is a reliable partner for its customers, configuring customised solutions tailored to individual requirements and offering an extensive range of products and components to produce cost-effective bespoke systems.

Cortem Group labels its products with a non-removable adhesive label featuring a hologram and an alphanumeric univocal code, as a safety measure against the illegal sale of fakes so that all the products are guaranteed as original. Non-compliance with the International standards entails serious risks for the environment, especially for those working daily on the plants.



Application sectors:

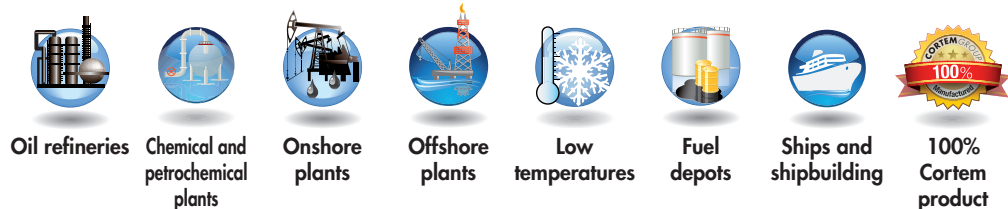

CERTIFICATION DATA FOR ENCLOSURES WITH TERMINALS

Classification:	Group II	Category 2GD		
Installation: EN 60079.14	zone 1 - zone 2 (Gas)	zone 21 - zone 22 (Dust)		
Marking:	CE 0722 Ex II 2GD Ex eb IIC T6/T5/T4 Gb - Ex tb IIIC T75°C/T110°C Db IP66			
	CE 0722 Ex II 2GD Ex e ia IIC T6/T5/T4 Gb - Ex ia IIIC T75°C/T110°C Db IP66			
	CE 0722 Ex II 2GD Ex eb ia IIC T6/T5/T4 Gb - Ex tb ia IIIC T75°C/T110°C Db IP66			
Certification:	ATEX	CESI 03 ATEX 333		
	IEC Ex	CES 13.0001	All IEC Ex, TR CU and INMETRO certification data can be downloaded from www.cortemgroup.com	
	TR CU	DISPONIBLE		
Standards:	CENELEC EN 60079-0: 2012+A11:2013, EN 60079-7: 2015, EN 60079-11: 2012 ed alla DIRETTIVA EUROPEA 2014/34/UE and EUROPEAN DIRECTIVE 2014/34/UE IEC 60079-0: 2011, IEC 60079-7: 2015, IEC 60079-11: 2011, IEC 60079-31: 2013			
Ambient Temp.:	See "ambient temperature range" table			
Degree of protection:	IP66			

CTBE... series (Ex e) and (Ex i) stainless steel junction boxes

AMBIENT TEMPERATURE RANGE

AMBIENT TEMPERATURE	TEMPERATURE CLASS	MAXIMUM SURFACE TEMPERATURE	MAXIMUM TERMINAL OPERATING TEMPERATURE
-40°C +40°C	T6	T75°C	+80°C
-40°C +55°C	T5	T75°C	+95°C

LOW AND HIGH TEMPERATURE RANGE (accordingly with the temperature allowed by the terminals)

AMBIENT TEMPERATURE	TEMPERATURE CLASS	MAXIMUM SURFACE TEMPERATURE	MAXIMUM TERMINAL OPERATING TEMPERATURE
-60°C +40°C	T6	T75°C	+80°C
-60°C +55°C	T5	T75°C	+95°C
-60°C +65°C**	T5	T75°C	+95°C

** For this temperature range the maximum dissipated power shall be reduced by 25% and the nominal current by 15%







TEMPERATURE RANGE FOR SIGNALING (max. 1 A for not Ex i circuits, max. 100 mA for 'Ex i' circuits)

AMBIENT TEMPERATURE	TEMPERATURE CLASS	MAXIMUM SURFACE TEMPERATURE	MAXIMUM TERMINAL OPERATING TEMPERATURE
-40°C +60°C	T6	T75°C	+80°C

TEMPERATURE RANGE FOR SIGNALING (max. 10 A for not Ex i circuits, max. 100 mA for 'Ex i' circuits)

AMBIENT TEMPERATURE	TEMPERATURE CLASS	MAXIMUM SURFACE TEMPERATURE	MAXIMUM TERMINAL OPERATING TEMPERATURE
-60°C +85°C	T4	T110°C	+120°C

CERTIFICATION DATA OF ENCLOSURES WITH EQUIPMENT (FIELDBUS, PROXIMATOR, HEATER...)

Classification:	Group II	Category 2GD		
Installation: EN 60079.14	zone 1 - zone 2 (Gas)	zone 21 - zone 22 (Dust)		
Marking:	CE 0722  II2GD - Ex eb IIC T6/T5 Gb - Ex tb IIIC T85°C/T100°C Db - IP66			
	CE 0722  II(1)GD - Ex eb ib mb [ia Ga] IIC T4 Gb - Ex tb [ia Da] IIIC T85°C Db IP66			
Certification:	ATEX	CML 16 ATEX 3163X		
	IEC Ex	CML 16.0074X	All IEC Ex certification data can be downloaded from www.cortemgroup.com	
Standards:	CENELEC EN 60079-0: 2012, EN 60079-7: 2015, EN 60079-28: 2015, EN 60079-31: 2014 and EUROPEAN DIRECTIVE 2014/34/UE IEC 60079-0: 2011-06, IEC 60079-7: 2015, IEC 60079-28: 2015, IEC 60079-31:2013			
 Ambient Temp.:	 -40°C (-50°C) +40°C 		With temperature class T6 and maximum surface temperature T85°C.	
	 -40°C (-50°C) +55°C 		With temperature class T5 and maximum surface temperature T100°C.	
Degree of protection:	IP66			

CTBE... series (Ex e) and (Ex i) stainless steel junction boxes

MECHANICAL FEATURES

Body and lid:	AISI 316L stainless steel
Gasket:	Resistant to acids, hydrocarbons and high temperatures, located between body and lid. Ensures consistent protection to IP66 during use
Certification label:	Stainless steel plate riveted onto lid
Bolts and screws:	Stainless steel
Earth screws:	Stainless steel. On inside and outside of body complete with anti-rotation brackets
Mounting:	AISI 316L stainless steel feet

ACCESSORIES AVAILABLE ON REQUEST/ SPECIAL REQUESTS

- Internal anti-condensation coating RAL 2004 (pure orange)
- External epoxy coating in different colour (specify the RAL number)
- Possible drilling of the enclosure bottom
- Breather valve Code ECD-210S; Drain valve code ECD-210S
- Internal mounting plate: stainless steel (code B...-484)
- Earth screws in stainless steel
- Terminal block mounting rails (code OBO2060/S)
- ATEX-CERTIFIED TERMINALS: terminals must be chosen from the list of approved manufacturers: Cabur, Phoenix, ABB Entelec, Wago, Weidmuller. When supplied as an Ex i enclosure (for low-voltage instruments), it comes with suitably identified blue terminals.
- Hole options: through holes with no threading
- Only use cable glands that meet ATEX, IECEx directive requirements. Use gaskets and lock nuts on entries to ensure IP66 protection.**

OVERVIEW OF SIZES

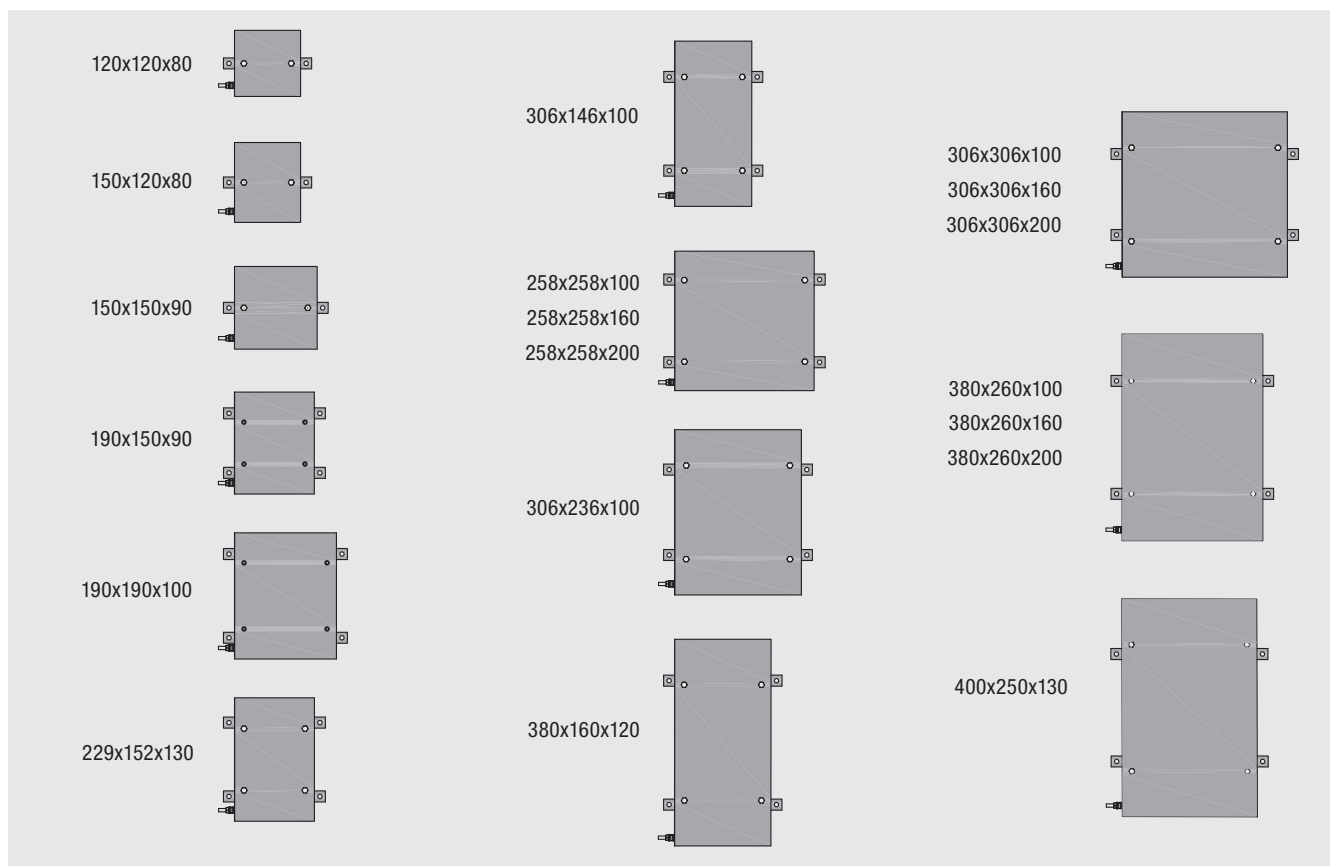

CTBE... series (Ex e) and (Ex i) stainless steel junction boxes

ENCLOSURE SELECTION CHART

Code	Outside dimensions				Mounting		N. of feet for the mounting	N. of screws on cover	Weight Kg
	A	B	C	C1	X	Y			
CTBE121208	120	120	80	90	135	43	2	2	1,02
CTBE151208	150	120	80	90	135	73	2	2	1,16
CTBE151509	150	150	90	100	165	73	2	2	1,42
CTBE191509	190	150	90	100	165	113	2	4	1,69
CTBE191910	190	190	100	110	205	113	2	4	2,06
CTBE221513	229	152	130	140	167	152	2	4	2,37
CTBE262610	258	258	100	110	273	181	4	4	3,29
CTBE262616	258	258	160	170	273	181	4	4	4,01
CTBE262620	258	258	200	210	273	181	4	4	4,46
CTBE301410	306	146	100	110	160	228	4	4	2,56
CTBE302310	306	236	100	110	250	228	4	4	3,47
CTBE303010	306	306	100	110	320	228	4	4	4,18
CTBE303016	306	306	160	170	320	228	4	4	5,04
CTBE303020	306	306	200	210	320	228	4	4	5,57
CTBE381612	380	160	120	130	175	303	4	4	3,46
CTBE382610	380	260	100	110	275	303	4	4	4,40
CTBE382616	380	260	160	170	275	303	4	4	5,30
CTBE382620	380	260	200	210	275	303	4	4	5,86
CTBE402513	400	250	130	140	265	323	4	4	4,91

DIMENSIONAL DRAWING

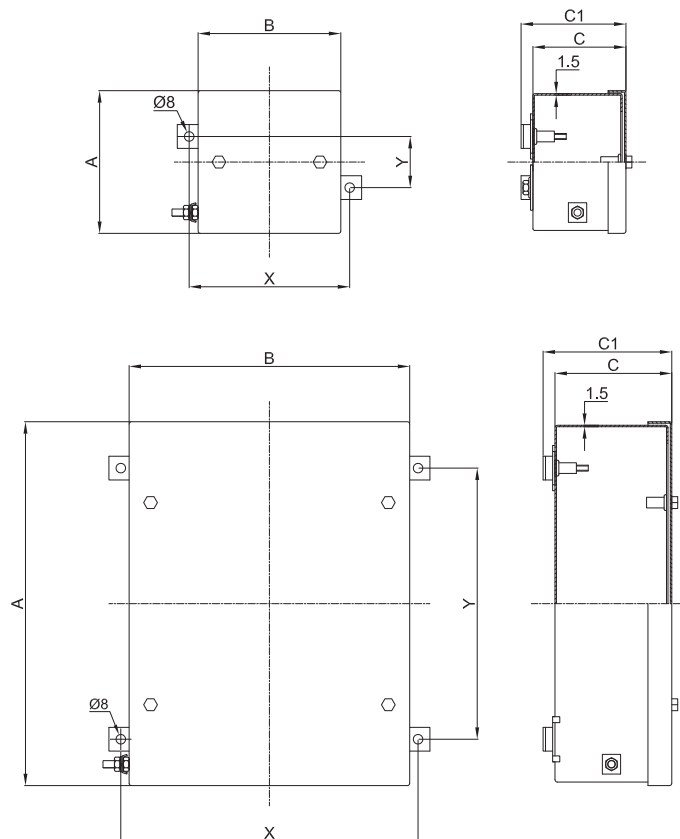

Dimensions in mm

CTBE... series (Ex e) and (Ex i) stainless steel junction boxes

THREAD COMPARISON CHART

D Thread diameter	01	1	2	3	4	5	6	7	8
ISO 261/965	16x1.5	20x1.5	25x1.5	32x1.5	40x1.5	50x1.5	63x1.5	75x1.5	90x1.5
Through hole	Ø17	Ø20.5	Ø25.5	Ø32.5	Ø40.5	Ø50.5	Ø63.5	Ø75.5	Ø90.5

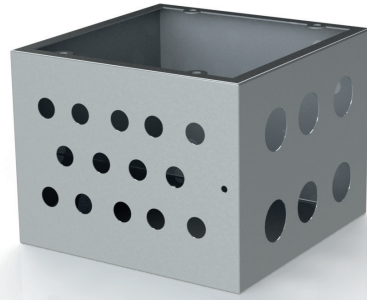

As required by the current standard, holes can be drilled by Cortem or by authorized partners who hold a production notification in accordance with ATEX Directive .

TYPE OF ENCLOSURE	HOLE DRILLING IN BODY																			
	Sides A and C										Sides B and D									
	Drilling area mm	MAXIMUM QUANTITY PER HOLE TYPE									Drilling area mm	MAXIMUM QUANTITY PER HOLE TYPE								
		01	1	2	3	4	5	6	7	8		01	1	2	3	4	5	6	7	8
CTBE121208	75x35	2	2	2	-	-	-	-	-	-	75x35	2	2	2	-	-	-	-	-	-
CTBE151208	75x35	2	2	2	1	-	-	-	-	-	105x35	3	3	2	1	-	-	-	-	-
CTBE151509	105x45	4	3	2	2	1	-	-	-	-	105x45	4	3	2	2	1	-	-	-	-
CTBE191509	105x45	4	3	2	2	1	-	-	-	-	145x45	6	4	3	3	2	-	-	-	-
CTBE191910	145x55	8	6	4	3	2	-	-	-	-	145x55	8	6	4	3	2	-	-	-	-
CTBE221513	107x85	6	6	4	4	2	-	-	-	-	184x85	10	10	8	6	3	-	-	-	-
CTBE262610	213x50	11	5	5	4	3	-	-	-	-	213x50	11	5	5	4	3	-	-	-	-
CTBE262616	213x110	18	15	14	8	6	3	3	2	2	213x100	18	15	9	8	6	4	2	2	2
CTBE262620	213x150	28	20	18	12	9	6	4	3	2	213x150	28	20	18	12	9	6	4	3	2
CTBE301410	100x50	5	3	2	2	1	-	-	-	-	260x50	14	9	7	5	4	-	-	-	-
CTBE302310	190x50	10	7	5	4	3	-	-	-	-	260x50	14	9	7	5	4	-	-	-	-
CTBE303010	260x50	14	9	7	5	4	-	-	-	-	260x50	14	9	7	5	4	-	-	-	-
CTBE303016	260x110	24	18	17	11	8	6	3	3	2	260x110	24	18	17	11	8	6	3	3	2
CTBE303020	260x150	35	25	22	15	12	8	6	4	2	260x150	35	25	22	15	12	8	6	4	2
CTBE381612	115x70	6	6	4	3	2	1	1	-	-	335x70	30	16	14	9	6	5	4	-	-
CTBE382610	215x50	11	8	5	4	3	-	-	-	-	335x50	18	10	9	7	5	-	-	-	-
CTBE382616	215x110	18	16	14	9	6	5	3	2	2	335x110	30	24	21	14	10	8	4	3	3
CTBE382620	215x150	28	20	18	12	9	6	4	3	2	335x150	45	30	28	18	15	10	8	4	3
CTBE402513	205x80	12	10	8	7	3	3	2	2	-	335x80	18	16	14	12	6	5	4	3	-

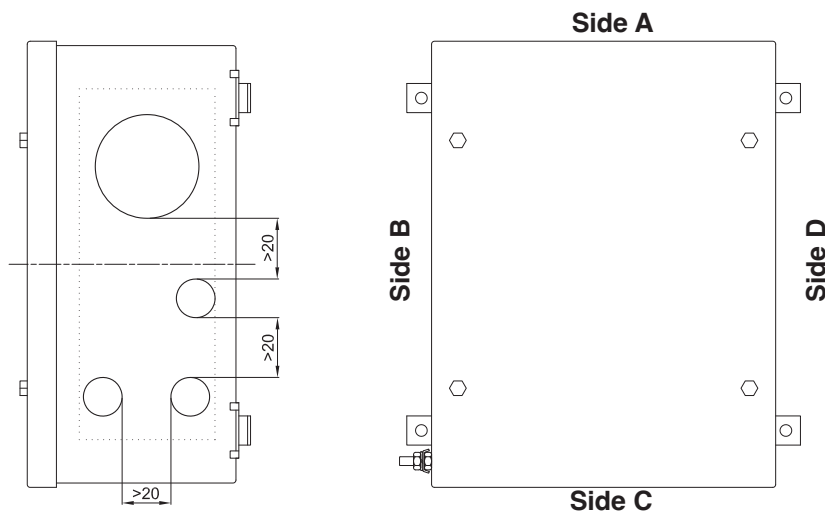



These enclosures are customized based on size, on the number of terminals or cables they are due to accommodate, or taking into account the number of cable entries and cabling requirements inside a system. Hence we can produce tailor-made solutions as long as you provide us with the appropriate parameters required at the quote request stage, such as the number of cable glands, unions or sealing fittings to be installed, so that we can determine the most suitable size of enclosure. All terminals can be fitted with your requested accessories and mounted on special rails that are fastened to the enclosure's internal mounting plates. Terminal strips can be arranged in various ways, as specified by the customer and always within the limits allowed by the certificate. The options are vertical, horizontal, in a number of rows, or on different levels using suitable spacers.

ELECTRICAL FEATURES

Rated voltage: 1000 V
Rated frequency: 50 / 60 Hz

Modular terminals

Terminal cross-sectional area: 1.5; 2.5; 4; 6; 10; 25; 35; 70; 95; 120; 185; 240; 300 [mm²]
Rated current: 8 - 400 [A]

Marking	Terminal type	Description
Ex II 2GD Ex e IIC T... Gb - Ex tb IIIC T... Db IP66	Ex e terminals only	Enclosures containing increased safety terminals to standard EN 60079-7
Ex II 2GD Ex e ia IIC T... Gb - Ex tb ia IIIC T... Db IP66	Ex e and Ex i terminals	Enclosures containing increased safety terminals and intrinsic safety terminals to standards EN 60079-7 and EN 60079-11
Ex II 2GD Ex ia IIC T... Gb - Ex ia IIIC T... Db IP66	Ex i terminals only	Enclosures containing intrinsic safety terminals to standard EN 60079-11; enclosures are still category 2

CTBE... series Features of junction boxes with terminals

Examples of terminal strips with minimum installation distances

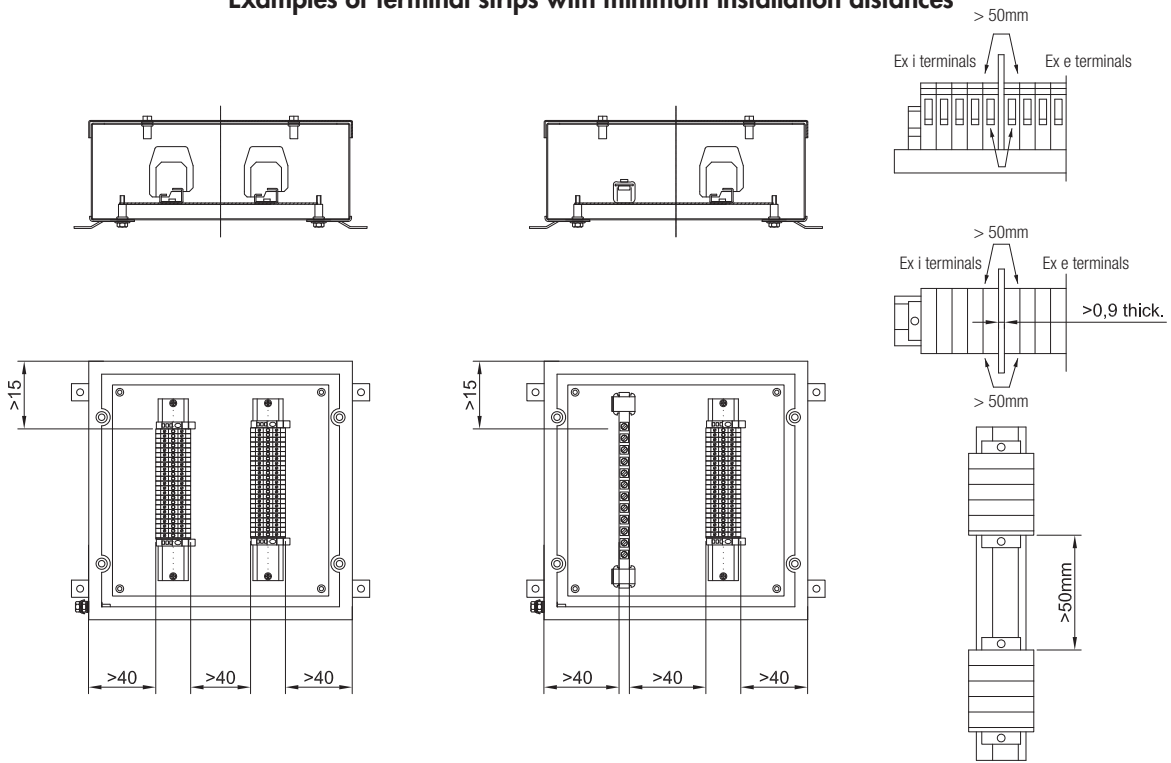

Notes:

Reference must be made to the minimum distances given, bearing in mind the space required for internal wiring.

Only ATEX-certified terminals are allowed inside the enclosures.

Ex i rated terminals must be suitably labelled or coloured differently so they are clearly identifiable.

Ex i cable entries must be suitably identified with either labelling or blue markings on cable glands or the enclosure's sides.

TYPE OF ENCLOSURE	MAXIMUM NUMBER OF TERMINALS HOUSED									
	TERMINAL CROSS-SECTIONAL AREA									
	1.5	2.5	4	6	10	16	25	35	50	70
CTBE121208	8	5	-	-	-	-	-	-	-	-
CTBE151208	14	10	-	-	-	-	-	-	-	-
CTBE151509	20	14	-	-	-	-	-	-	-	-
CTBE191509	29	20	-	-	-	-	-	-	-	-
CTBE191910	36	25	21	15	-	-	-	-	-	-
CTBE221513	38	26	22	16	-	-	-	-	-	-
CTBE262610	2x42	2x29	2x24	2x18	-	-	-	-	-	-
CTBE262616	2x42	2x29	2x24	2x18	2x14	2x12	8	-	-	-
CTBE262620	2x42	2x29	2x24	2x18	2x14	2x12	8	-	-	-
CTBE301410	56	39	32	24	-	-	-	-	-	-
CTBE302310	2x56	2x39	2x32	2x24	-	-	-	-	-	-
CTBE303010	2x56	2x39	2x32	2x24	-	-	-	-	-	-
CTBE303016	2x56	2x39	2x32	2x24	2x19	2x16	11	-	-	-
CTBE381612	77	54	45	33	26	22	16	-	-	-
CTBE303020	2x56	2x39	2x32	2x24	2x19	2x16	11	11	10	9
CTBE382610	2x77	2x54	2x45	2x33	2x26	2x22	16	16	14	12
CTBE382616	2x77	2x54	2x45	2x33	2x26	2x22	16	16	14	12
CTBE382620	2x77	2x54	2x45	2x33	2x26	2x22	16	16	14	12
CTBE402513	2x83	2x58	2x48	2x36	2x28	2x23	17	17	-	-

Eg. 2x22= 2 rows of 22 terminals (total 44 terminals). The maximum number of standard terminals refers to the mounting of CABUR and/or WEIDMULLER terminals. The data in the table are given as a rough guide only based solely on the size of the enclosures and the space taken up by the terminals.

CTBE... series Features of junction boxes with terminals

The permissible maximum power dissipation, in order to retain a T6 temperature class with an ambient temperature up to 40°C or T5 class with an ambient temperature of 55°C, is not to exceed the values given in the tables below.

For an ambient temperature of +60°C or +65°C, maximum power dissipation must be reduced by 25%, and rated current reduced by 15%.

The maximum current values for terminal strips used for low-voltage circuits (signalling units) with a T6 temperature class and maximum ambient temperature of +60°C are as follows:

- 1 A for Ex e circuits;
- 100mA for Ex ia circuits.

The values given in the tables on the coming pages refer to the maximum number of conductors allowed for a conductor with a given cross-sectional area and a given maximum current. All incoming wires and active internal links (made by wires) count as wires. Earth connections (i.e. passive connections) do not count.

When DIN/Omega rails are installed on the internal mounting plate (instead of using the relevant mounting plate fastening holes), the number of terminals may be slightly less than the number given in the tables.

Other types of terminals can be used up to the space limit of the box. Whatever the case, all terminals used shall be ATEX and/or IEC Ex certified. Size 35mm² terminals can be used for conductors with a cross-sectional area of 25mm².

The maximum number of terminals and maximum number of rows given in the tables is an indicative value: you must take into account the cable entries on the sides of the boxes. The internal overall dimensions of cable glands/lock nuts and the overall dimensions of conductors must be taken into consideration to allow for wiring.

In some cases, it may be necessary to reduce the number of terminals or the number of rows.

Example of how to calculate the maximum number of conductors.

Referring to table of the maximum number of conductors for CTB262620: 6 conductors with 6mm² cross-section with 26A continuous current is the limit of this box. Consequently, box CTB262620 is suitable for containing 3 x 6mm² terminals (2 conductors for each terminal) with a max. current of 26A.

There is space for 32 x 6mm² terminals in the box. The remaining 29 terminals (32-3) can be added and used for low-current circuits indicated in the "yellow-coloured" area of the table (in this case max. 8-10A).

Combined mounting for electrical circuits with different sized cables is possible provided the values given are used proportionally. For example:

Nominal X-sect. area (mm ²)	Current (A)	Quantity	Capacity
2.5	16	10 (out of 30)	33%
16	50	12 (out of 48)	25%
25	63	36 (out of 90)	40%
		Total	98% <100%

CTBE... series Features of junction boxes with terminals

Table showing maximum power dissipation and current for ambient temperature +40°C and +55°C



Enclosure	P [W]	Maximum current [A] per conductor cross-sectional area in mm ²															
		1.5	2.5	4	6	10	16	25	35	50	70	95	120	150	185	240	300
CTBE121208	5,3	11	15	21	26	37	49	67	-	-	-	-	-	-	-	-	-
CTBE151208	5,3	11	15	21	26	37	49	67	-	-	-	-	-	-	-	-	-
CTBE151509	5,5	11	15	21	26	37	49	67	-	-	-	-	-	-	-	-	-
CTBE191509	6,2	11	15	21	26	37	49	67	-	-	-	-	-	-	-	-	-
CTBE191910	6,2	11	15	21	26	37	49	67	-	-	-	-	-	-	-	-	-
CTBE221513	6,2	11	15	21	26	37	49	67	-	-	-	-	-	-	-	-	-
CTBE262610	10,6	11	15	21	26	37	49	67	-	-	-	-	-	-	-	-	-
CTBE262616	10,6	11	15	21	26	37	49	67	-	-	-	-	-	-	-	-	-
CTBE262620	11,2	11	15	21	26	37	49	67	-	-	-	-	-	-	-	-	-
CTBE301410	10,6	11	15	21	26	37	49	67	-	-	-	-	-	-	-	-	-
CTBE302310	11,2	11	15	21	26	37	49	67	-	-	-	-	-	-	-	-	-
CTBE303010	11,2	11	15	21	26	37	49	67	-	-	-	-	-	-	-	-	-
CTBE303016	11,2	11	15	21	26	37	49	67	-	-	-	-	-	-	-	-	-
CTBE381612	11,2	11	15	21	26	37	49	67	-	-	-	-	-	-	-	-	-
CTBE303020	12,2	11	15	21	26	37	49	67	80	98	122	122	147	147	147	147	147
CTBE382610	12,2	11	15	21	26	37	49	67	80	98	122	122	147	147	147	147	147
CTBE382616	12,2	11	15	21	26	37	49	67	80	98	122	122	147	147	147	147	147
CTBE382620	12,2	11	15	21	26	37	49	67	80	98	122	122	147	147	147	147	147
CTBE402513	12,2	11	15	21	26	37	49	67	80	98	122	122	147	147	147	147	147

Table showing maximum power dissipation and current for ambient temperature +60°C and +65°C

Enclosure	P [W]	Maximum current [A] per conductor cross-sectional area in mm ²															
		1.5	2.5	4	6	10	16	25	35	50	70	95	120	150	185	240	300
CTBE121208	3,9	9	12	17	22	31	41	57	-	-	-	-	-	-	-	-	-
CTBE151208	3,9	9	12	17	22	31	41	57	-	-	-	-	-	-	-	-	-
CTBE151509	4,1	9	12	17	22	31	41	57	-	-	-	-	-	-	-	-	-
CTBE191509	4,6	9	12	17	22	31	41	57	-	-	-	-	-	-	-	-	-
CTBE191910	4,6	9	12	17	22	31	41	57	-	-	-	-	-	-	-	-	-
CTBE221513	4,6	9	12	17	22	31	41	57	-	-	-	-	-	-	-	-	-
CTBE262610	7,9	9	12	17	22	31	41	57	-	-	-	-	-	-	-	-	-
CTBE262616	7,9	9	12	17	22	31	41	57	-	-	-	-	-	-	-	-	-
CTBE262620	8,4	9	12	17	22	31	41	57	-	-	-	-	-	-	-	-	-
CTBE301410	7,9	9	12	17	22	31	41	57	-	-	-	-	-	-	-	-	-
CTBE302310	8,4	9	12	17	22	31	41	57	-	-	-	-	-	-	-	-	-
CTBE303010	8,4	9	12	17	22	31	41	57	-	-	-	-	-	-	-	-	-
CTBE303016	8,4	9	12	17	22	31	41	57	-	-	-	-	-	-	-	-	-
CTBE381612	8,4	9	12	17	22	31	41	57	-	-	-	-	-	-	-	-	-
CTBE303020	9,1	9	12	17	22	31	41	57	68	83	103	103	125	125	125	125	125
CTBE382610	9,1	9	12	17	22	31	41	57	68	83	103	103	125	125	125	125	125
CTBE382616	9,1	9	12	17	22	31	41	57	68	83	103	103	125	125	125	125	125
CTBE382620	9,1	9	12	17	22	31	41	57	68	83	103	103	125	125	125	125	125
CTBE402513	9,1	9	12	17	22	31	41	57	68	83	103	103	125	125	125	125	125

CTBE... series Features of junction boxes with terminals

Instructions for determining which enclosure is best suited based on the planned number of conductors and terminals.

-  : In this section of the table that has not been filled in, once you have followed the instructions and complied with the values given for the enclosure's internal wiring, you can add as many terminals as you want up to the space limit of the box.
-  : Any wiring that falls within this section of the table that has not been filled in is not covered by the certificate.

"C. No." row: the values given refer to the maximum number of CABUR terminals physically allowed inside the relevant enclosure. These values are expressed as the product of the rows multiplied by the number of terminals.

"W. No." row: the same as above, but this time referring to Weidmuller terminals.

The terminal brands are mentioned just to give an idea of the quantity of terminals that can be housed inside the enclosure.

The other values given in the cells along the table's diagonal define the maximum number of conductors allowed, based on their cross-sectional area and maximum current.

Tables showing maximum number of conductors

$$(N^\circ \text{ of terminals} = \frac{n^\circ \text{ of conductors}}{2})$$

CTBE121208

Current (A)	Cross-sectional areain mm ²						
	1,5	2,5	4	6	10	16	25
1							
8	15	25					
10	9	16	22				
11	8	13	18	24			
15		7	10	13			
21			5	7	9	12	
26				4	6	8	10
37					3	4	5
49						2	3
67							2
C. No.							
W. No.	8	5					

Maximum power dissipation with T6 temperature class must not exceed 5,3W

CTBE151208

Current (A)	Cross-sectional areain mm ²						
	1,5	2,5	4	6	10	16	25
1							
8	15	25					
10	9	16	22				
11	7	13	18	24			
15		7	10	13			
21			5	7	9	12	
26				4	6	8	10
37					3	4	5
49						2	3
67							2
C. No.							
W. No.	14	10					

Maximum power dissipation with T6 temperature class must not exceed 5,3W

CTBE151509

Current (A)	Cross-sectional areain mm ²						
	1,5	2,5	4	6	10	16	25
1							
8	14	24					
10	9	15	22				
11	7	12	18	24			
15		6	10	13	18	25	
21			5	7	9	13	16
26				4	6	8	11
37					3	4	5
49						2	3
67							2
C. No.							
W. No.	20	14					

Maximum power dissipation with T6 temperature class must not exceed 5,5W

CTBE191509

Current (A)	Cross-sectional areain mm ²						
	1,5	2,5	4	6	10	16	25
1							
8	16	27	38				
10	10	17	24	33			
11	8	14	20	27	39		
15		7	11	14	21	28	
21			6	7	11	14	19
26				5	7	9	12
37					3	5	6
49						3	3
67							2
C. No.							
W. No.	29	20					

Maximum power dissipation with T6 temperature class must not exceed 5,5W

CTBE191910

Current (A)	Cross-sectional areain mm ²						
	1,5	2,5	4	6	10	16	25
1							
8	16	27	38				
10	10	17	24	33			
11	8	14	20	27	39		
15		7	11	14	21	28	
21			6	7	11	14	19
26				5	7	9	12
37					3	5	6
49						3	3
67							2
C. No.		23	19	15			
W. No.	36	25	21	15			

Maximum power dissipation with T6 temperature class must not exceed 6,2W

CTBE221513

Current (A)	Cross-sectional areain mm ²						
	1,5	2,5	4	6	10	16	25
1							
8	16	27	38				
10	10	17	24	33			
11	8	14	20	27	39		
15		7	11	14	21	28	
21			6	7	11	14	19
26				5	7	9	12
37					3	5	6
49						3	3
67							2
C. No.		24	20	16			
W. No.	38	26	22	16			

Maximum power dissipation with T6 temperature class must not exceed 6,2W

CTBE262610

Current (A)	Cross-sectional areain mm ²						
	1,5	2,5	4	6	10	16	25
1							
8	20	34	50	68	102		
10	13	22	32	44	65		
11	11	18	26	36	54	76	104
15		9	14	19	29	41	56
21			7	10	15	21	29
26				6	10	14	19
37					5	7	9
49						4	5
67							3
C. No.		2x27	2x22	2x18			
W. No.	2x42	2x29	2x24	2x18			

Maximum power dissipation with T6 temperature class must not exceed 10,6W

CTBE262616

Current (A)	Cross-sectional areain mm ²						
	1,5	2,5	4	6	10	16	25
1							
8	20	34	50	68	102		
10	13	22	32	44	65		
11	11	18	26	36	54	76	104
15		9	14	19	29	41	56
21			7	10	15	21	29
26				6	10	14	19
37					5	7	9
49						4	5
67							3
C. No.		2x27	2x22	2x18	2x14	2x12	8
W. No.	2x42	2x29	2x24	2x18	2x14	2x12	8

Maximum power dissipation with T6 temperature class must not exceed 10,6W

CTBE262620

Current (A)	Cross-sectional areain mm ²						
	1,5	2,5	4	6	10	16	25
1							
8	20	33	49	68	103		
10	13	21	32	44	66		
11	11	18	26	36	54	77	107
15		9	14	19	29	41	57
21			7	10	15	21	29
26				6	10	14	19
37					5	7	9
49						4	5
67							3
C. No.		2x27	2x22	2x18	2x14	2x12	8
W. No.	2x42	2x29	2x24	2x18	2x14	2x12	8

Maximum power dissipation with T6 temperature class must not exceed 11,2W

CTBE... series Features of junction boxes with terminals

Tabelle per il massimo numero di conduttori

CTBE301410

Current (A)	Cross-sectional area in mm ²						
	1,5	2,5	4	6	10	16	25
1							
8	20	34	50	68	102		
10	13	22	32	44	65		
11	11	18	26	36	54	76	104
15		9	14	19	29	41	56
21			7	10	15	21	29
26				6	10	14	19
37					5	7	9
49						4	5
67							3
C. No.		35	30	24			
W. No.	56	39	32	24			

Maximum power dissipation with T6 temperature class must not exceed 10,6W

CTBE302310

Current (A)	Cross-sectional area in mm ²						
	1,5	2,5	4	6	10	16	25
1							
8	20	33	49	68	103		
10	13	21	32	44	66		
11	11	18	26	36	54	77	107
15		9	14	19	29	41	57
21			7	10	15	21	29
26				6	10	14	19
37					5	7	9
49						4	5
67							3
C. No.		2x35	2x30	2x24			
W. No.	2x56	2x39	2x32	2x24			

Maximum power dissipation with T6 temperature class must not exceed 11,2W

CTBE303010

Current (A)	Cross-sectional area in mm ²						
	1,5	2,5	4	6	10	16	25
1							
8	20	33	49	68	103		
10	13	21	32	44	66		
11	11	18	26	36	54	77	107
15		9	14	19	29	41	57
21			7	10	15	21	29
26				6	10	14	19
37					5	7	9
49						4	5
67							3
C. No.		2x35	2x30	2x24			
W. No.	2x56	2x39	2x32	2x24			

Maximum power dissipation with T6 temperature class must not exceed 11,2W

CTBE303016

Current (A)	Cross-sectional area in mm ²						
	1,5	2,5	4	6	10	16	25
1							
8	20	33	49	68	103		
10	13	21	32	44	66		
11	11	18	26	36	54	77	107
15		9	14	19	29	41	57
21			7	10	15	21	29
26				6	10	14	19
37					5	7	9
49						4	5
67							3
C. No.		2x35	2x30	2x24	2x19	2x16	11
W. No.	2x56	2x39	2x32	2x24	2x19	2x16	11

Maximum power dissipation with T6 temperature class must not exceed 6,2W

CTBE381612

Current (A)	Cross-sectional area in mm ²						
	1,5	2,5	4	6	10	16	25
1							
8	20	33	49	68	103		
10	13	21	32	44	66		
11	11	18	26	36	54	77	107
15		9	14	19	29	41	57
21			7	10	15	21	29
26				6	10	14	19
37					5	7	9
49						4	5
67							3
C. No.		49	41	33	26	22	16
W. No.	77	54	45	33	26	22	16

Maximum power dissipation with T6 temperature class must not exceed 11,2W

CTBE303020

Current (A)	Cross-sectional area in mm ²									
	1,5	2,5	4	6	10	16	25	35	50	70
1										
8	21	34	51	71	107	153				
10	13	22	33	45	69	98	136			
11	11	18	27	38	57	81	113	141		
15		9	15	20	31	43	61	76	92	
21			7	10	16	22	31	39	47	59
26				7	10	14	20	25	31	38
37					5	7	10	12	15	19
49						4	6	7	9	11
67							3	4	5	6
80								3	3	4
98									2	3
122										2
C. No.		2x35	2x30	2x24	2x19	2x16	11	11	10	9
W. No.	2x56	2x39	2x32	2x24	2x19	2x16	11	11	10	9

Maximum power dissipation with T6 temperature class must not exceed 12,2W

CTBE382610, CTBE382616, CTBE382620

Current (A)	Cross-sectional area in mm ²									
	1,5	2,5	4	6	10	16	25	35	50	70
1										
8	21	34	51	71	107	153				
10	13	22	33	45	69	98	136			
11	11	18	27	38	57	81	113	141		
15		9	15	20	31	43	61	76	92	
21			7	10	16	22	31	39	47	59
26				7	10	14	20	25	31	38
37					5	7	10	12	15	19
49						4	6	7	9	11
67							3	4	5	6
80								3	3	4
98									2	3
122										2
C. No.		2x49	2x41	2x33	2x26	2x22	16	16	14	12
W. No.	2x77	2x54	2x45	2x33	2x26	2x22	16	16	14	12

Maximum power dissipation with T6 temperature class must not exceed 12,2W

CTBE402513

Current (A)	Cross-sectional area in mm ²						
	1,5	2,5	4	6	10	16	25
1							
8	21	34	51	71	107	153	
10	13	22	33	45	69	98	136
11	11	18	27	38	57	81	113
15		9	15	20	31	43	61
21			7	10	16	22	31
26				7	10	14	20
37					5	7	10
49						4	6
67							3
80							
98							
122							
C. No.		2x52	2x44	2x36	2x28	2x23	17
W. No.	2x83	2x58	2x48	2x36	2x28	2x23	17

Maximum power dissipation with T6 temperature class must not exceed 12,2W

CTBE... series Features of junction boxes with terminals

Codes of terminals used to determine maximum number of terminals

The other values given in the cells along the table's diagonal define the maximum number of conductors allowed, based on their cross-sectional area and maximum current.

mm ²	1.5	2.5	4	6	10	16	25	35
Cabur		CBD 2	CBD 4	CBD 6	CBD 10	CBD 16	CBD 35	
Weidmuller	WDU 1.5	WDU 2.5	WDU 4	WDU 6	WDU 10	WDU 16	WDU 35	

mm ²	50	70	95	120	150	185	240	300
Cabur	CBD 50	CBD 70	GPM95/CC	GPM150/CC		GPM240/CC		
Weidmuller	WDU 50	WDU 70	WDU 70/95	WDU 120/150		WDU 240		

ATEX - IECEx label for terminal enclosures

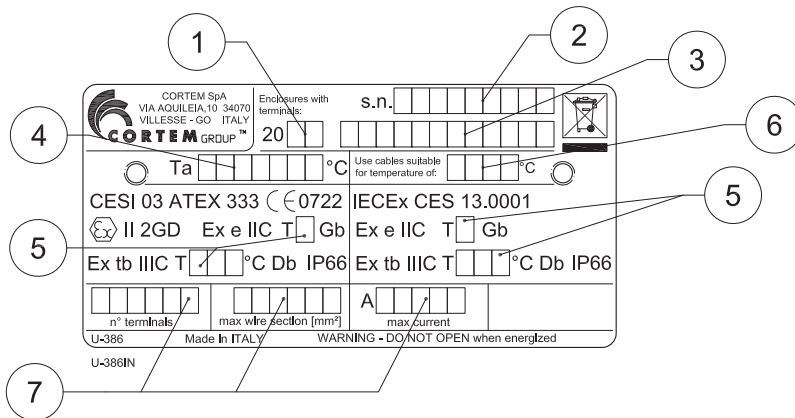

Data filled in:

1. year of manufacture
2. serial number
3. product code
4. ambient temperature
5. temperature class and maximum surface
6. temperature of cables
7. electrical specs per certificate

TYPICAL EXAMPLES OF TERMINAL BLOCK INSTALLATION

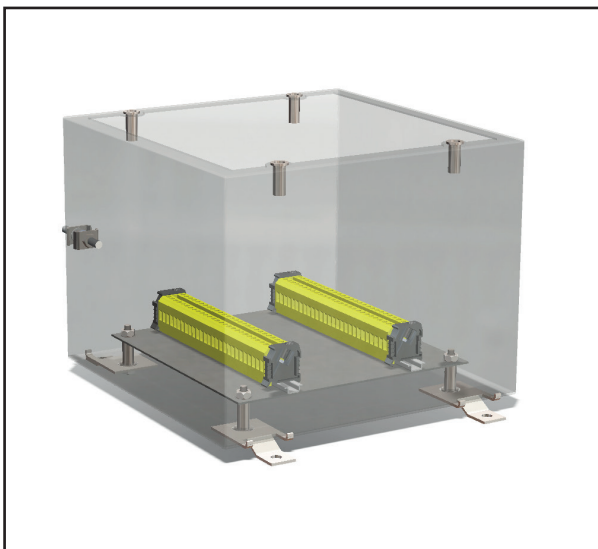

Example of feed-through terminal installation on top hat rail fastened to stainless steel internal mounting plate.

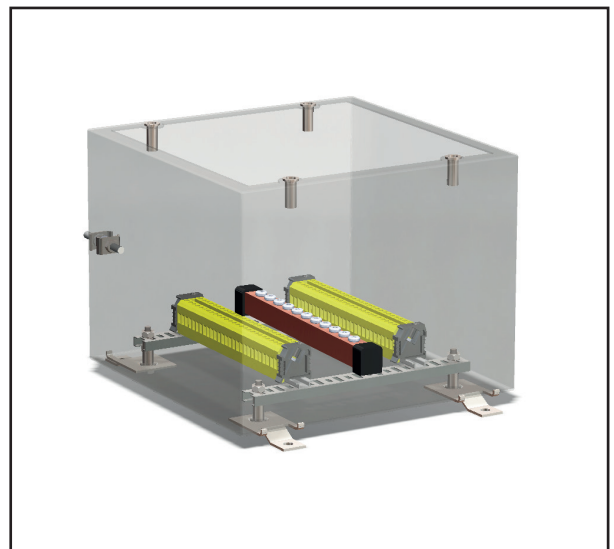

Example of feed-through terminal installation on top hat rail fastened on two pre-drilled mounting rails.

DON'T FORGET TO ORDER THE ACCESSORIES

Example: Enclosure type **CTB484820** + Internal frame **B26-484** + Cable glands, unions + other...see key



CTBE... series Accessories available on request and spare parts

ILLUSTRATION	DESCRIPTION	MODEL	DIMENSIONS		CODE	KEY
			A	B		
	Internal mounting plates Stainless steel	CTBE121208	60	60	B12-484	 
		CTBE151208	90	60	B151-484	
		CTBE151509	90	90	B15-484	
		CTBE191509	130	90	B191-484	
		CTBE191910	130	130	B19-484	
		CTBE221513	170	90	B22-484	
		CTBE262610	200	200	B26-484	
		CTBE262616				
		CTBE262620				
		CTBE301410	245	85	B303-484	
		CTBE302310	245	175	B302-484	
		CTBE303010	245	245	B30-484	
		CTBE381612				
		CTBE303020				
		CTBE381612	320	100	B383-484	
		CTBE382610	320	200	B38-484	
CTBE382616						
CTBE382620						
CTBE402513	340	190	B40-484			
ILLUSTRATION	DESCRIPTION	MODEL	FEATURES		CODE	KEY
	Terminal block mounting rails		Steel rails cut to size		OBO2060/S	 
	Universal clip for grouping cables in single bundle	For 6-13mm cable	Material: polyamide Hole for M6 screw for fastening	OBO2037/6-13	 	
		For 12-20mm cable		OBO2037/12-20		
		For 16-24mm cable		OBO2037/16-24		
		For 18-30mm cable		OBO2037/18-30		
		For 27-43mm cable		OBO2037/27-43		
	Breather and drain valve	Thread diameter ISO 7-R 3/8"	Material: stainless steel		ECD-210S ECDE...	 
	Entry blanking plugs and cable glands	For models and codes, visit www.cortemgroup.com			 	