

# CCA-03EX

- Easy installation
- Low energy consumption
- New COB LED technology
- Zone 1, 2, 21, 22

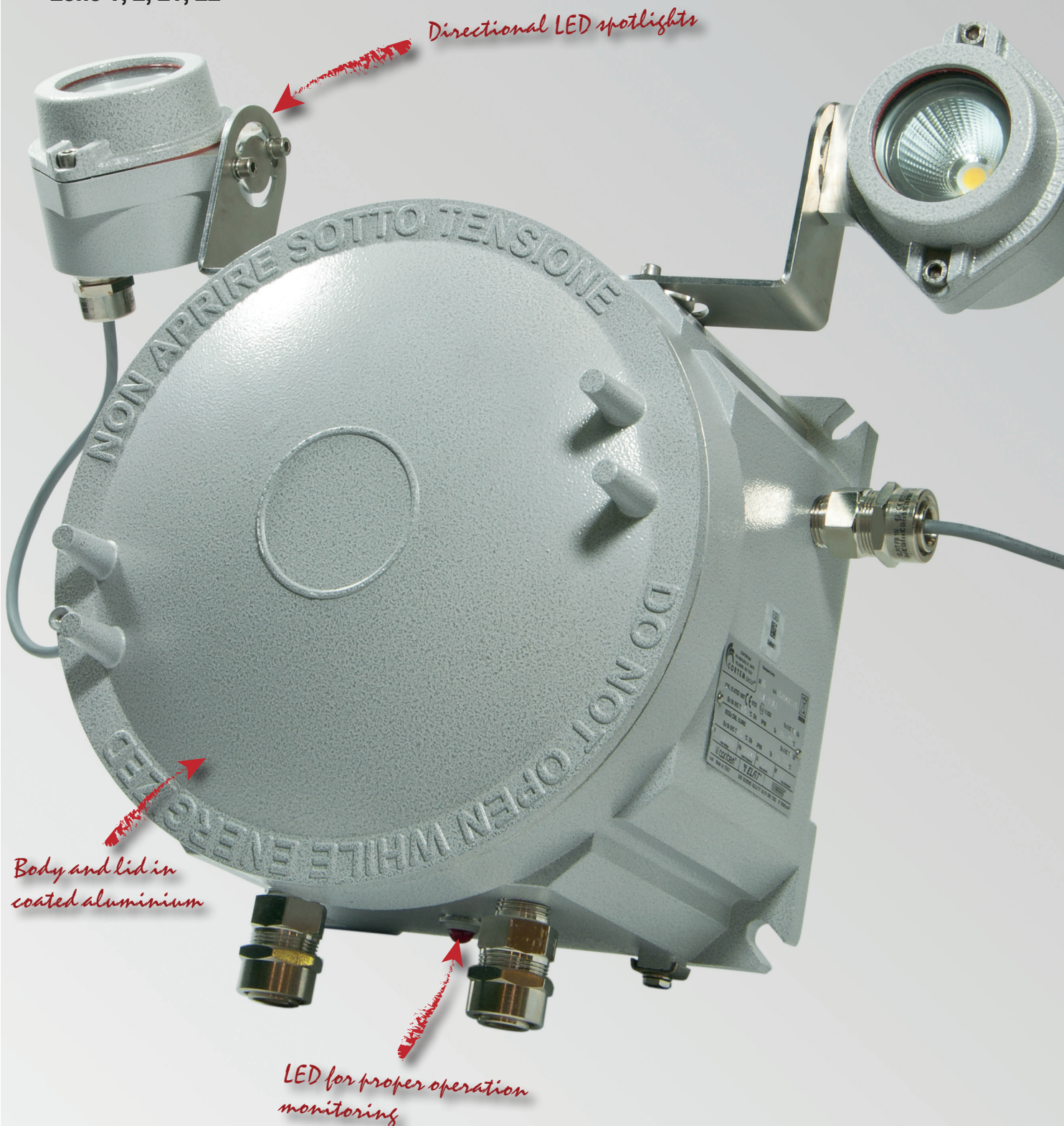

# CCA-03EX Lighting fixtures for safety warnings

The LED lighting fixtures for safety warnings CCA-03EX series is designed for installation in areas with risk of explosion where lighting may be stopped due to abnormal, unusual or accidental situations.

The CCA-03EX lighting fixture can be installed in indoor and outdoor environments and it can operate both in normal and emergency service, with a maximum duration of about 2 hours. In case of interruption of the supply voltage, electronics automatically turn on the lighting fixture. The optimal placement of the terminal strip allows a simple wiring, with the possibility of installing more equipment thanks to two threaded hubs studied for the through-wiring. CCA-03EX lighting fixture has a compact size and features two directional LED spotlights. The use of LED COB (Chip on Board) as light source, housed in a junction box with IP66 protection, allows high performance in terms of lumens, low maintenance costs and long life. The presence of reflectors specifically designed for this type of source allows to increase the lighting performance and to direct the light in a well-precise areas thanks to the directionality of the system. Battery replacement after a fault in the emergency circuit or due to battery exhaustion, is indicated by the red LED turning off. In case of emergency, the red LED turns off by activating the LED COB power supply through the battery.

## Application sectors:

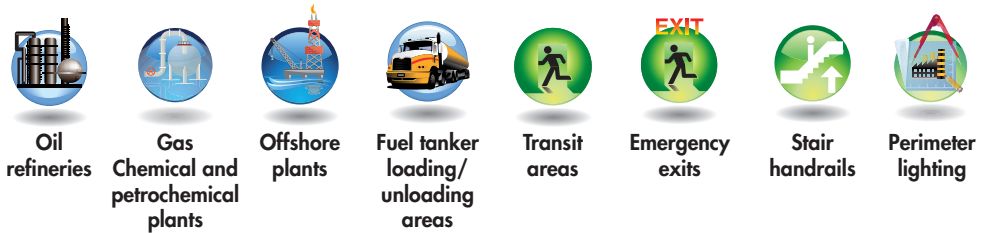

## CERTIFICATION DATA

<b>Classification:</b>	Group II	Category 2GD		
<b>Installation:</b> EN 60079.14	zone 1 - zone 2 (Gas)	zone 21 - zone 22 (Dust)		
<b>Marking:</b>	CE 0722 Ex II 2GD Ex d IIC T6 Gb - Ex tb IIIC T85°C Db IP66			
<b>Certification:</b>	ATEX CML 15 ATEX 1007			
	IEC Ex IECEx CML 15.0002	All IEC Ex certification data can be downloaded at <a href="http://www.cortemgroup.com">www.cortemgroup.com</a>		
<b>Standards:</b>	CENELEC EN 60079-0: 2012, EN 60079-1: 2007, EN 60079-31: 2014 and EUROPEAN DIRECTIVE 2014/34/UE IEC 60079-0: 2011, IEC 60079-1: 2014-06, IEC 60079-31: 2013 European Directive 2004/108 Electromagnetic compatibility European Directive 2012/19/UE, 2002/96/CE, 2003/108/CE WEEE European Directive 2011/65/UE RoHS			
<b>Class temperature:</b>	85°C (T6)			
<b>Ambient temperature:</b>	Standard -20°C +55°C			
<b>Degree of protection:</b>	IP66			

# CCA-03EX Lighting fixtures for safety warnings



ORIGINAL PRODUCT

## MECHANICAL FEATURES

<b>Body and lid:</b>	Low copper content aluminium alloy
<b>Internal frames:</b>	Stainless steel
<b>External adjustable brackets:</b>	Stainless steel
<b>Glass face:</b>	Shock and temperature resistant tempered glass
<b>Gaskets:</b>	Acid and hydrocarbon resistant silicone
<b>Bolts and screws:</b>	Stainless steel
<b>Assembly:</b>	See "Dimensional drawing CCA-03EX"
<b>Entries:</b>	2 x 1/2" NPT entries. Fixture kit with n.1 PLG1NB plug and n.2 FB1NBK cable gland
<b>Coating:</b>	Polyester coating Ral 7035 (Light grey)
<b>Corrosion Resistance:</b>	The STANDARD of the aluminium alloy used by Cortem has passed the tests required by standards EN60068-2-30 (hot/humid cycles) and EN60068-2-11 (salt mist tests)

## EXPLODED DIAGRAM OF CCA-03EX LIGHTING FIXTURES FOR SAFETY WARNINGS

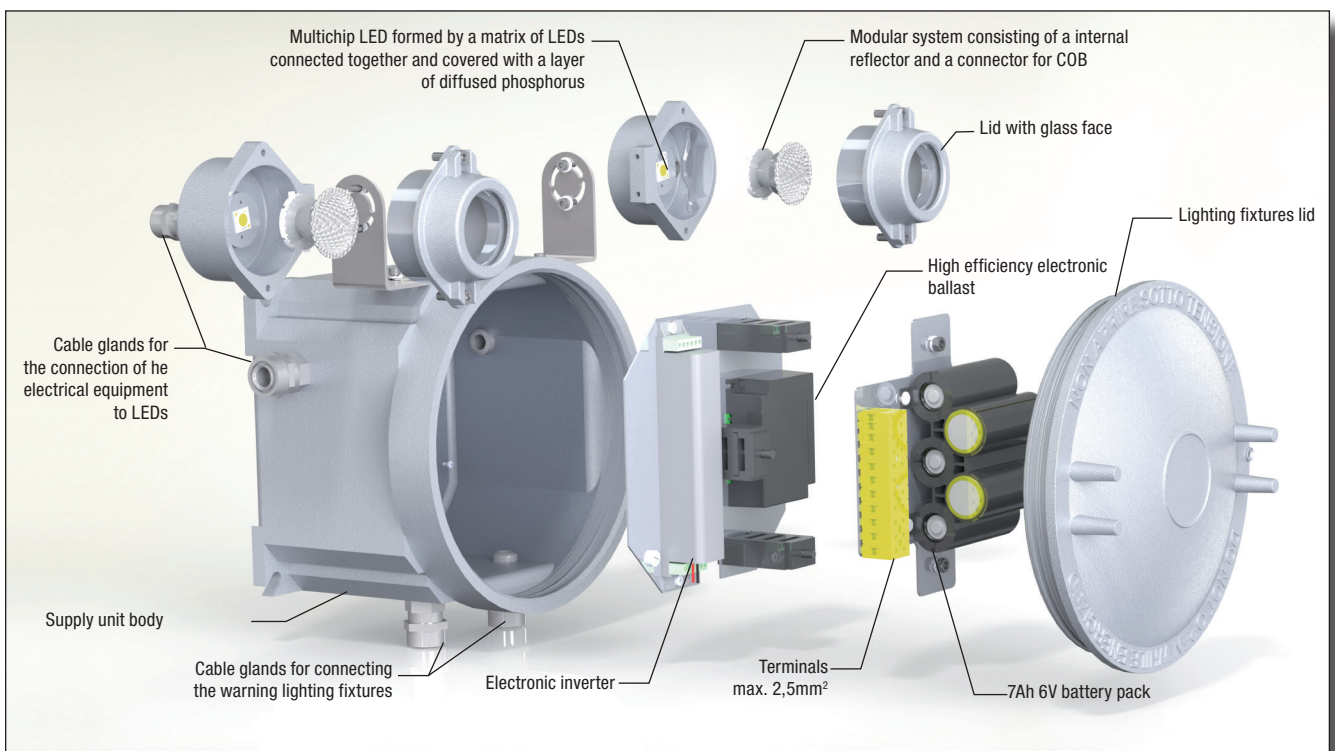

## CCA-03EX Lighting fixtures for safety warnings

Electrical features	CCA-03EX
Power supply:	110-240 Vac $\pm$ 10%
Rated frequency:	50-60 Hz $\pm$ 5%
Power consumption:	20 W
Connection:	Direct connection to terminal board L, N, PE. Section 2,5 mm <sup>2</sup> , suitable for loop-in/loop-out
Power factor:	>0,90
Rated current:	100 mA
EMC (electromagnetic compatibility):	EN 55015, EN 61000-3-2, EN 61000-4-..., EN 61547
THD (total harmonic distortion):	<20% 100-277 Vac
Over-voltage protection:	2 kV
Driver performances:	Over-Voltage protection, Over-Current protection, Short-Circuit protection
Battery:	7 Ah, 6 V. Discharge time 2 hours
Photometric features	
LED Multichip:	Cree CXA
Viewing angle:	30°
Colour temperature:	3500 K
CRI:	80
Instant Restrike:	YES
<b>Lumen:</b>	<b>595 lm (x2)</b>
<b>Maximum light intensity:</b>	<b>1968 cd (x2)</b>
<b>Overall efficiency:</b>	<b>59,5 lm/W</b>



**DETAIL OF LED SPOTLIGHTS**

LED spotlights adjustable both horizontally and vertically to allow the directionality of light.

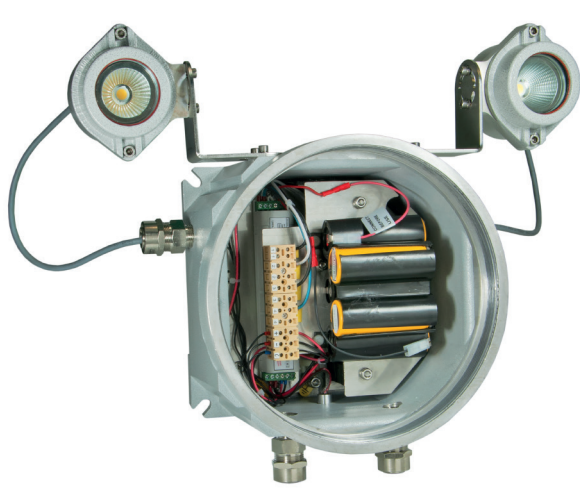

**INSIDE VIEW**

Internal electrical part completely wired with silicone rubber cables with protective glass braid for high temperatures.

# CCA-03EX Lighting fixtures for safety warnings

Code	Type Lamp	Watt	Class	Max surface temperature °C	Weight kg	 mm
CCA-03EX	LED	20 W	T6	85	14	

## DIMENSIONAL DRAWING

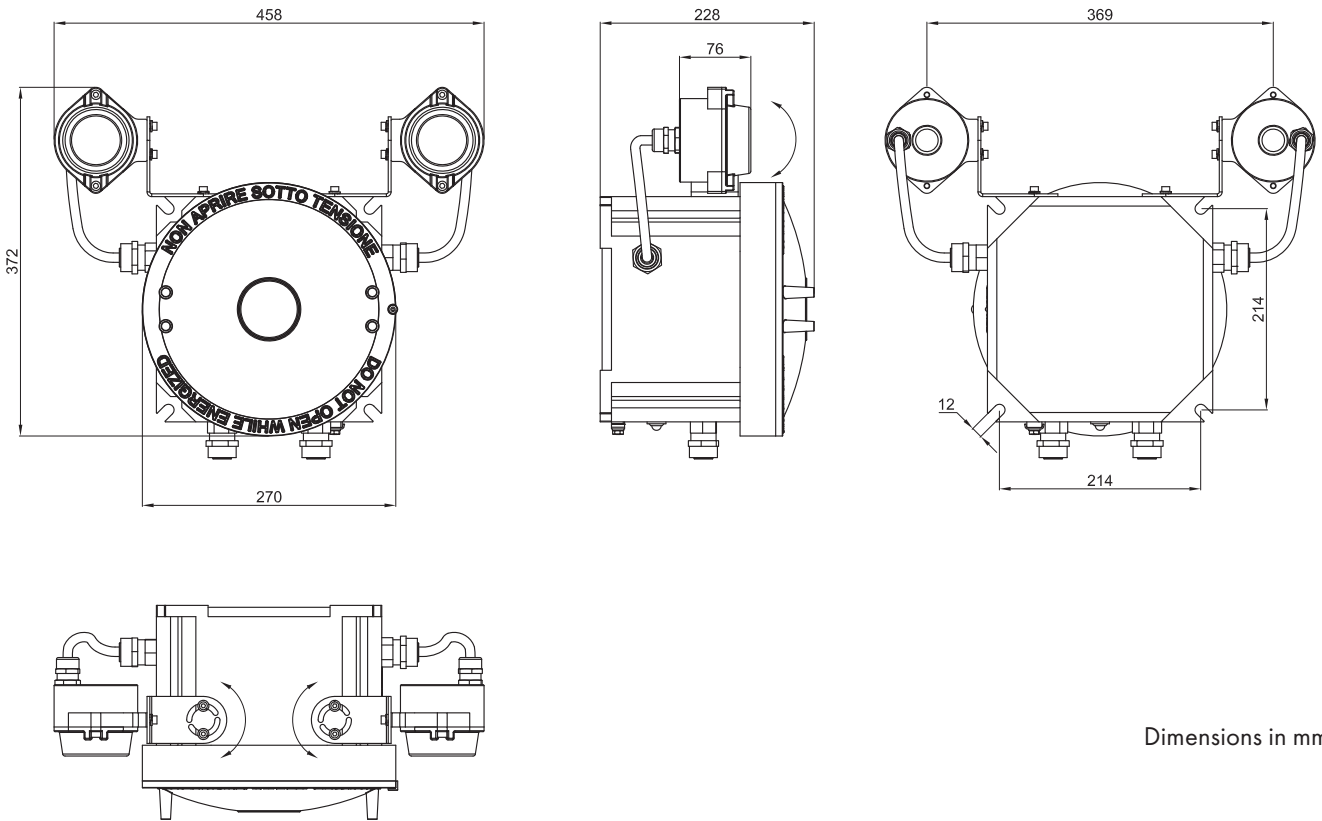
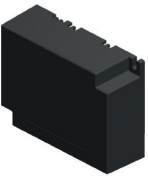

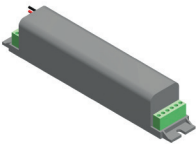



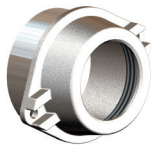





ILLUSTRATION	DESCRIPTION	FEATURES	CODE	KEY
	Driver	110-240 Vac	LEDDCCA-03EX	
	Electronic inverter	90/264 V	INVDCCA-03EX	
	Battery pack	7 Ah 6V NiCd	G-0309	

## CCA-03EX Lighting fixtures for safety warnings

ILLUSTRATION	DESCRIPTION	FEATURES	CODE	KEY
	Lid with glass face	Material: aluminium lid tempered glass	M-0390	
	Gasket between body and cover	Material: silicone	K27-131S	



Example of lighting design made using CCA-03EX lighting fixtures for safety warnings

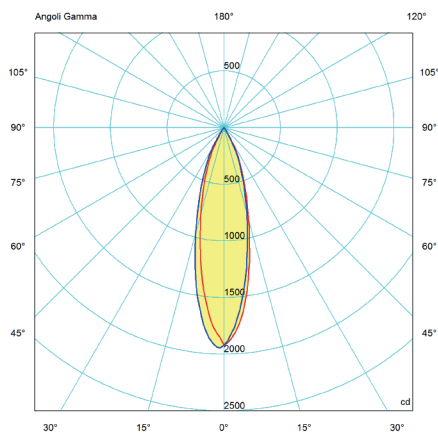

CCA-03EX Luminous flux: 600 lm

On Cortem Group web site you can download .LDT and .IES lighting data files for the design and simulation of lighting levels in 2D and 3D, rendering and ray tracing.

— = plane 90270  
— = plane 0180

# Notes

