

PYN, SPYN

Prese e spine

- Gruppo IIC
- Zona 1, 2, 21, 22
- In lega di alluminio
- Ergonomicità
- Possibilità di utilizzo delle spine con le prese di tipo industriale
- Adatte al funzionamento con temperature ambientali estreme

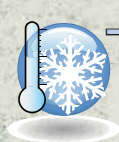

-60°C

Prese e spine progettate per basse temperature

Verniciatura poliesteri RAL7035

Leghe di alluminio a basso contenuto di rame

Piedini di fissaggio di fusione

Catena in acciaio



Serie PYN... SPYN... Prese e spine da 16 A ÷ 125 A

La serie di prese e spine PYN, SPYN è costituita da modelli da 16 A e 32 A e da modelli da 63 A e 125 A progettati con metodo di protezione 'Ex db eb, Ex tb e 'Ex eb, Ex tb' e testati per il funzionamento a basse temperature fino a -60°.

Le prese da 16A e 32A sono provviste di sezionatore interbloccato con la relativa spina ad esse sottese. La rotazione e chiusura/apertura in apposita camera a prova di esplosione garantisce la connessione del circuito elettrico solo dopo che la spina della serie SPYN è stata correttamente inserita nella sua sede e l'estrazione solo dopo che il circuito elettrico è stato elettricamente disconnesso. I modelli da 63A e 125A, invece, dovendo sopportare carichi elettrici elevati, sono equipaggiati da interruttore automatico magnetotermico.

La gamma comprende prese bipolari + terra (PE); tripolari + terra (PE) e tripolari + neutro + terra (PE), con portate di corrente da 16A e dimensioni ridotte ad un massimo di 125A e tensioni da 50V sino ad un massimo di 690VAC e frequenza massima di 50/60Hz. Tutti i modelli di spina possono essere utilizzati anche sulle normali prese industriali di tipo conforme alla norma IEC/EN 60309-2, mentre tutti i modelli di presa sono costruite in maniera da non permettere l'accoppiamento con le spine di tipo industriale.

Cortem Group applica sui suoi prodotti un'etichetta olografica di sicurezza non riposizionabile completa di codice alfanumerico univoco di autenticazione, al fine di combattere la vendita illegale di imitazioni e contraffazioni e assicurare l'autenticità dei propri prodotti. Il non rispetto delle norme internazionali comporta gravi rischi sia per l'ambiente, ma soprattutto per coloro che operano quotidianamente sugli impianti.

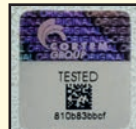

Settori di impiego:



Raffinerie petrolifere



Impianti chimici e petrochimici



Impianti onshore



Impianti offshore



Pontili di carico scarico petrolio



Basse temperature



Deposito combustibili



100% prodotto Cortem

DATI DI CERTIFICAZIONE

Classificazione:	Gruppo II	Categoria 2GD		
Installazione: EN 60079.14	zona 1 - zona 2 (Gas)	zona 21 - zona 22 (Polveri)		
Esecuzione:	CE 0722 Ex II 2 GD Ex db eb IIC T... Gb; Ex tb IIC T...°C Db			Presca
	CE 0722 Ex II 2 GD Ex eb IIC T... Gb; Ex tb IIC T...°C Db			Spina
Certificato:	ATEX	IMQ 20 ATEX 049X		
	IEC Ex	IMQ 21.0003X	Per tutti i dati di certificazione IEC Ex scaricare il certificato dal sito www.cortemgroup.com	
Norme:	CENELEC EN 60079-0: 2018, EN 60079-1: 2014, EN 60079-7: 2017, EN 60079-31: 2014 ed alla direttiva europea 2014/34/UE. IEC 60079-0: 2017, IEC 60079-1: 2014, IEC 60079-7: 2017, IEC 60079-31: 2022 Direttiva RoHS 2002/95/CE.			
Modelli:	16 A		32 A	
Classe di temperatura:	T85°C (T6)		T100°C (T4)	
Temp. Ambiente:	-60°C +60°C		-60°C +60°C	
Modelli:	63 A		125 A	
Classe di temperatura:	T85°C (T6)		T140°C (T3)	T134°C (T4)
Temp. Ambiente:	-60°C +60°C		-60°C +55°C	-60°C +49°C
Grado di protezione:	IP66			

Serie PYN... SPYN... Prese e spine da 16 A ÷ 125 A

PYN..., SPYN... 16 A

SPYN..., PYN... 32 A

PYN... 63 A, 125 A

SPYN... 63 A e 125 A



CARATTERISTICHE MECCANICHE

Corpo presa:

In lega di alluminio a basso contenuto di rame completa di piedini per il fissaggio a parete e di tappo di chiusura alveoli a baionetta in plastica, con colore identificativo e provvisto di catenella imperdibile

Coperchio:

A vite, in lega di alluminio a basso contenuto di rame. Utilizzato per l'accesso e il collegamento elettrico della presa

Spina:

In lega di alluminio a basso contenuto di rame completa di ghiera di bloccaggio in materiale plastico con colore identificativo della tensione di utilizzo

Spinotti:

In ottone con finitura di nichelatura

Guarnizione:

Siliconica resistente agli acidi, agli idrocarburi ed alle alte temperature, collocata tra corpo e coperchio

Targhetta di certificato:

Adesiva collocata esternamente

Viteria:

In acciaio inox

Verniciatura:

Poliestere Ral 7035 (Grigio luce)

Resistenza alla corrosione:

Lo STANDARD della lega di alluminio utilizzata da Cortem ha superato i test previsti dalle norme EN60068-2-30 (cicli di caldo-umido) e EN60068-2-11 (prove in nebbia salina)

Le spine di corrente serie SPYN hanno la possibilità di essere utilizzate anche sulle prese di corrente del tipo stagno industriale. Infatti, il posizionamento dei pin di fase e terra e la ghiera colorata, che rispettano la codifica colore prevista dalla norma IEC/EN 60309-2 per le prese e spine di tipo industriale, le contraddistingue in funzione della tensione di alimentazione e della corrente di utilizzo.

Per una maggior comprensione, riportiamo il diagramma di posizionamento pin di terra (PE) e relative colorazioni, in accordo alla normativa IEC/EN 60309-2, per tensioni di impiego maggiori di 50V.

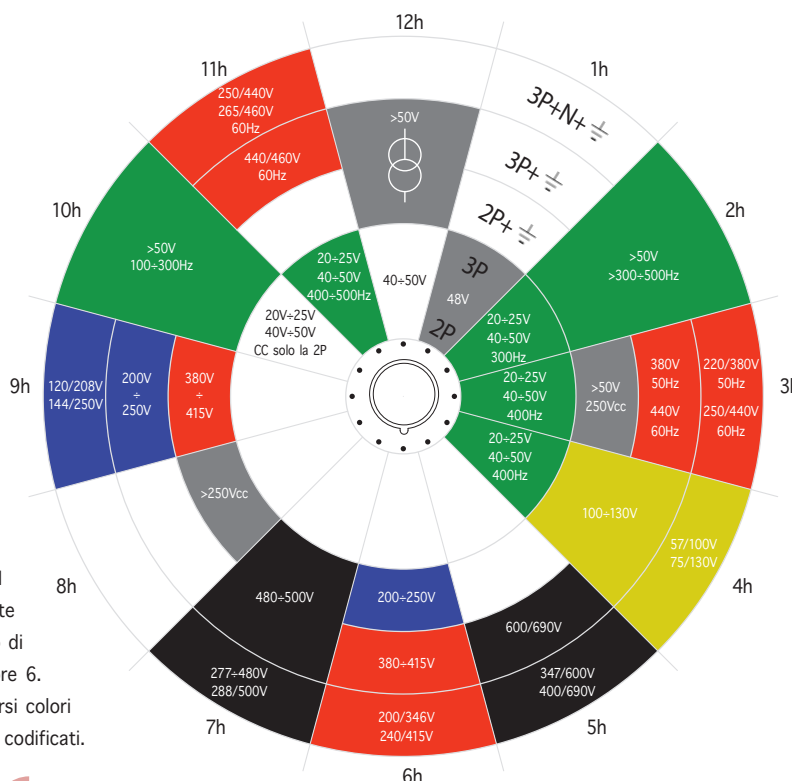

La posizione oraria h si determina con la presa vista di fronte osservando la posizione del contatto di terra rispetto al punto di riferimento principale posizionato sempre a ore 6.

Le diverse tensioni nominali inoltre si distinguono tramite diversi colori convenzionali codificati.

Serie PYN... SPYN... Prese e spine da 16 A ÷ 125 A

CARATTERISTICHE ELETTRICHE

Tensione nominale:	Max. 690 V
Frequenza nominale:	Max. 50/60 Hz
Corrente nominale:	16 A, 32 A, 63 A e 125 A
Entrata dei cavi:	n.2 sulla presa n.1 sulla spina
Sezione max. cavi:	per 16 A: 4 mm ² per 63 A: 10 - 16 mm ² per 32 A: 6 mm ² per 125 A: 35 - 50 mm ²

DISEGNO DIMENSIONALE

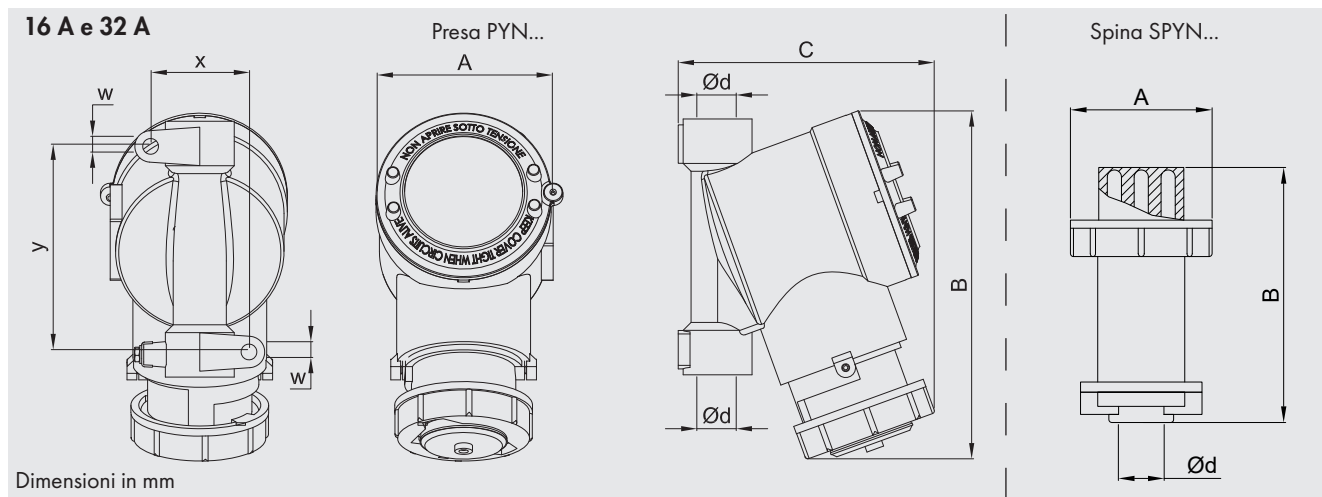

Dimensioni in mm

MODELLO	DIMENSIONI (mm)							PESO (Kg)
	A	B	C	y	x	w	Ø d	
PYN..16..	Ø 90	165	135	104	50	8	3/4" NPT	1,7
PYN..32..	Ø 120	240	175	140	80	8	1" NPT	2,1
SPYN..16..	Ø 66	116	-	-	-	-	3/4" NPT	0,3
SPYN..32..	Ø 92	145	-	-	-	-	1" NPT	0,6

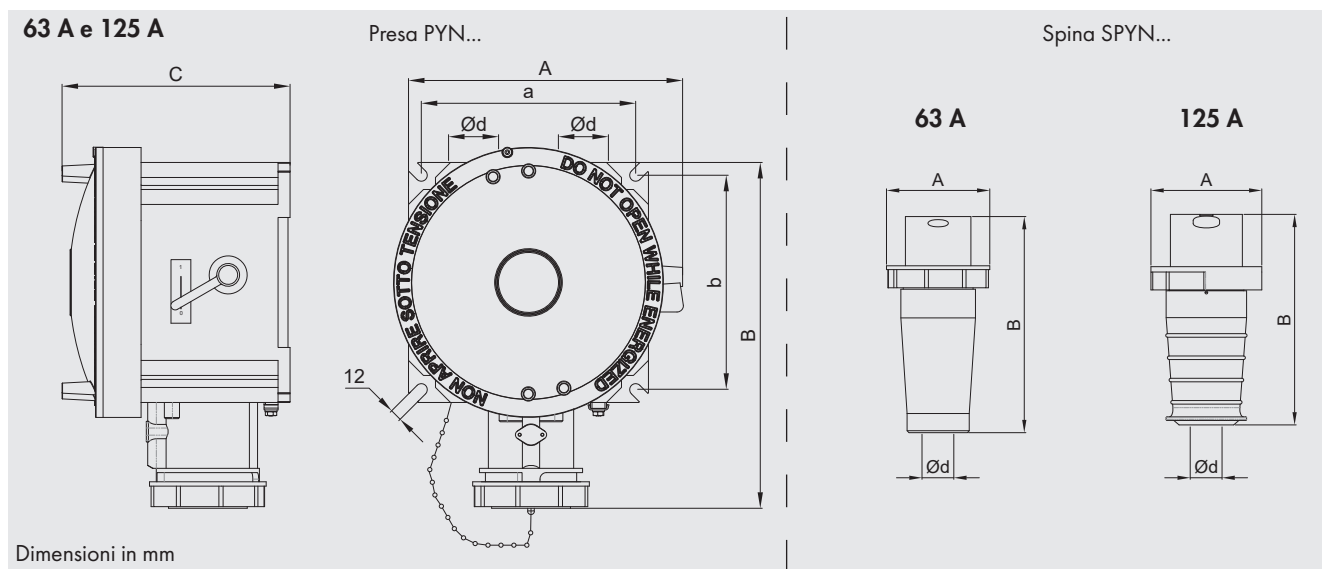



























Dimensioni in mm

MODELLO	DIMENSIONI (mm)						PESO (Kg)
	A	B	C	a	b	Ø d	
PYN..63..	280	337	210	213	213	1 1/2" NPT	11
PYN..125..	280	345	210	213	213	1 1/2" NPT	11,4
SPYN..63..	108	226	-	-	-	ISO M32x1,5	1,2
SPYN..125..	124	235	-	-	-	ISO M40x1,5	1,5

Serie PYN... SPYN... Prese e spine da 16 A ÷ 125 A

























TABELLA DI SELEZIONE CODICI

CORRENTE NOMINALE	NUMERO POLI	FREQUENZA Hz	TENSIONE NOMINALE V _{ac}	DISPOSIZIONE	PESO (Kg)	CODICE PRESA	CODICE SPINA
16 A	2P + 	50 / 60	20 / 25	 5h	1.70	PYN216V	SPYN216V
	2P + 	50 / 60	100 / 130	 4h	1.70	PYN216G	SPYN216G
	2P + 	50 / 60	200 / 250	 6h	1.70	PYN216B	SPYN216B
	2P + 	50 / 60	>50 to 250Vdc	 3h	1.70	PYN216GR	SPYN216GR
	2P + 	50 / 60	380 / 415	 9h	1.70	PYN216R	SPYN216R
	2P + 	50 / 60	480 / 500	 7h	1.70	PYN216N	SPYN216N
	3P + 	50 / 60	20 / 25	 5h	1.70	PYN316V	SPYN316V
	3P + 	50 / 60	200 / 250	 9h	1.70	PYN316B	SPYN316B
	3P + 	50 / 60	100 / 130	 4h	1.70	PYN316G	SPYN316G
	3P + 	50 / 60	380 / 415	 6h	1.70	PYN316R	SPYN316R
32 A	2P + 	50 / 60	200 / 250	 6h	2.10	PYN232B	SPYN232B
	2P + 	50 / 60	100 / 130	 4h	2.10	PYN232G	SPYN232G
	2P + 	50 / 60	380 / 415	 9h	2.10	PYN232R	SPYN232R

Caratteristiche conformi alla norma CEI EN 60309-1/60309-2

Serie PYN... SPYN... Prese e spine da 16 A ÷ 125 A

























TABELLA DI SELEZIONE CODICI

CORRENTE NOMINALE	NUMERO POLI	FREQUENZA Hz	TENSIONE NOMINALE V _{ac}	DISPOSIZIONE	PESO (Kg)	CODICE PRESA	CODICE SPINA
32 A	2P + 	50 / 60	20 / 25	 5h	2.10	PYN232V	SPYN232V
	3P + 	50 / 60	200 / 250	 9h	2.10	PYN332B	SPYN332B
	3P + 	50 / 60	100 / 130	 4h	2.10	PYN332G	SPYN332G
	3P + 	50 / 60	500	 7h	2.10	PYN332N	SPYN332N
	3P + 	50 / 60	380 / 415	 6h	2.10	PYN332R	SPYN332R
	3P + 	50 / 60	440	 11h	2.10	PYN332RR	SPYN332RR
	3P + 	50 / 60	20 / 25	 5h	2.10	PYN332V	SPYN332V
	3P + N + 	50 / 60	200 / 250	 9h	2.10	PYN432B	SPYN432B
	3P + N + 	50 / 60	100 / 130	 4h	2.10	PYN432G	SPYN432G
	3P + N + 	50 / 60	500	 7h	2.10	PYN432N	SPYN432N
	3P + N + 	50 / 60	380 / 415	 6h	2.10	PYN432R	SPYN432R
	3P + N + 	50 / 60	440	 11h	2.10	PYN432RR	SPYN432RR

Caratteristiche conformi alla norma CEI EN 60309-1/60309-2

Serie PYN... SPYN... Prese e spine da 16 A ÷ 125 A

























TABELLA DI SELEZIONE CODICI

CORRENTE NOMINALE	NUMERO POLI	FREQUENZA Hz	TENSIONE NOMINALE V _{cc}	DISPOSIZIONE	PESO (Kg)	CODICE PRESA	CODICE SPINA
63 A	2P + 	50 / 60	200 / 250	 6h	2.10	PYN263B	SPYN263B
	2P + 	50 / 60	380 / 415	 9h	2.10	PYN263R	SPYN263R
	3P + 	50 / 60	200 / 250	 9h	2.10	PYN363B	SPYN363B
	3P + 	50 / 60	500	 7h	2.10	PYN363N	SPYN363N
	3P + 	50 / 60	690	 5h	2.10	PYN363NN	SPYN363NN
	3P + 	50 / 60	380 / 415	 6h	2.10	PYN363R	SPYN363R
	3P + 	50 / 60	440	 11h	2.10	PYN363RR	SPYN363RR
	3P + N + 	50 / 60	200 / 250	 9h	2.10	PYN463B	SPYN463B
	3P + N + 	50 / 60	500	 7h	2.10	PYN463N	SPYN463N
	3P + N + 	50 / 60	690	 5h	2.10	PYN463NN	SPYN463NN
	3P + N + 	50 / 60	380 / 415	 6h	2.10	PYN463R	SPYN463R
	3P + N + 	50 / 60	440	 11h	2.10	PYN463RR	SPYN463RR

Caratteristiche conformi alla norma CEI EN 60309-1/60309-2

Serie PYN... SPYN... Prese e spine da 16 A ÷ 125 A

TABELLA DI SELEZIONE CODICI

CORRENTE NOMINALE	NUMERO POLI	FREQUENZA Hz	TENSIONE NOMINALE V _{ac}	DISPOSIZIONE	PESO (Kg)	CODICE PRESA	CODICE SPINA
125 A	2P + 	50 / 60	200 / 250	 6h	2.10	PYN2125B	SPYN2125B
	2P + 	50 / 60	380 / 415	 9h	2.10	PYN2125R	SPYN2125R
	3P + 	50 / 60	200 / 250	 9h	2.10	PYN3125B	SPYN3125B
	3P + 	50 / 60	500	 7h	2.10	PYN3125N	SPYN3125N
	3P + 	50 / 60	690	 5h	2.10	PYN3125NN	SPYN3125NN
	3P + 	50 / 60	380 / 415	 6h	2.10	PYN3125R	SPYN3125R
	3P + 	50 / 60	440	 11h	2.10	PYN3125RR	SPYN3125RR
	3P + N + 	50 / 60	200 / 250	 9h	2.10	PYN4125B	SPYN4125B
	3P + N + 	50 / 60	500	 7h	2.10	PYN4125N	SPYN4125N
	3P + N + 	50 / 60	690	 5h	2.10	PYN4125NN	SPYN4125NN
	3P + N + 	50 / 60	380 / 415	 6h	2.10	PYN4125R	SPYN4125R
	3P + N + 	50 / 60	440	 11h	2.10	PYN4125RR	SPYN4125RR

Caratteristiche conformi alla norma CEI EN 60309-1/60309-2

Serie PYN... SPYN... Prese e spine da 16 A ÷ 125 A

ILLUSTRAZIONE	DESCRIZIONE	MODELLO	CARATTERISTICHE	CODICE	LEGENDA
	Pressacavo	1 1/2" ISO 7/1 ISO M32 ISO M40	Materiale: ottone nichelato	NAV55B NAV321B NAV401B	 
	Tappo	1 1/2" ISO 7/1 ISO M32 ISOM40	Materiale: ottone nichelato	PLG5B PLG31 PLG41	 
	Ghiera colorata con attacco a baionetta	SPYN216...	Il colore contraddistingue le spine dalla differente tensione nominale o frequenza	M16-523/1/...	
		SPYN316...		M16-751/1/...	
		SPYN232... SPYN332...		M32-523/1/...	
		SPYN432...		M-766/1/...	
		SPYN263... SPYN363... SPYN463...		M-1014/...	
		SPYN2125... SPYN3125... SPYN4125...		M-1036/...	
	Tappo colorato provvisto di catenella impermeabile con attacco a baionetta	PYN216...	Il colore contraddistingue le spine dalla differente tensione nominale o frequenza	M-0384/1/...	
		PYN316...		M-0574/1/...	
		PYN232... PYN332...		M-0385/1/...	
		PYN432...		M-0564/1/...	
		PYN263... PYN363... PYN463...		M-0681/...	
		PYN2125... PYN3125... PYN4125...		M-0682/...	

SAFETY SYSTEM

Le prese da **16 A** e **32 A** sono dotate di sezionatore interno il quale permette, ruotando la spina annessa, di agire sulle operazioni di chiusura/apertura dei contatti che avvengono all'interno di un'apposita camera antideflagrante, garantendo così il contenimento di eventuali esplosioni in presenza di gas. Il circuito elettrico viene collegato solo dopo che la spina serie SPYN è stata correttamente inserita nella sua sede e la sua estrazione è garantita solo dopo aver scollegato il circuito elettrico.

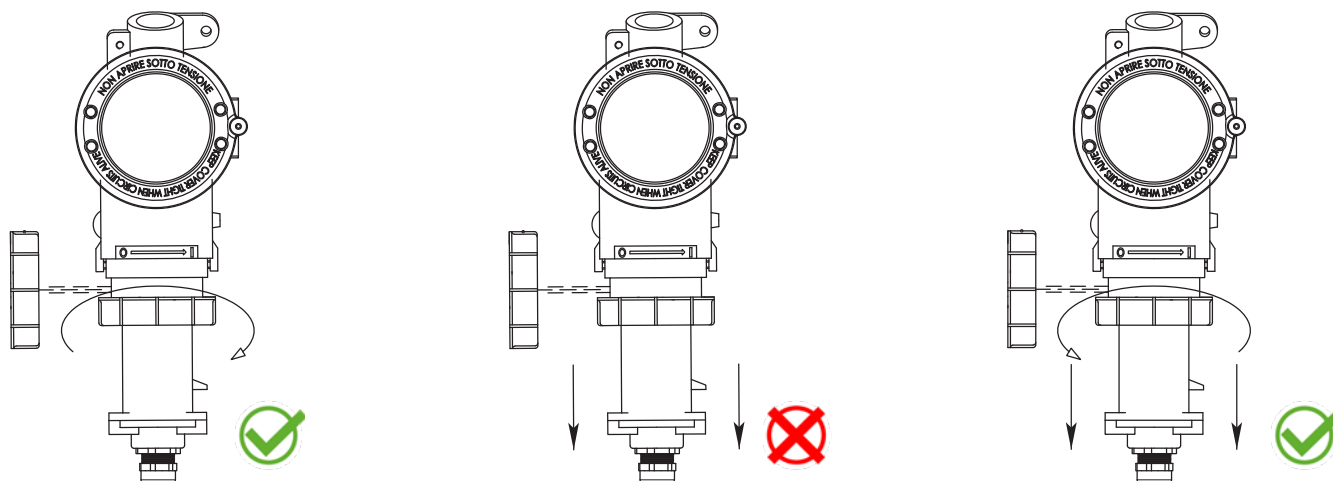

La spina non può essere rimossa dalla presa se non viene ruotata prima in senso antiorario scollegando il circuito elettrico interno.

Le prese da **63 A** e **125 A** sono dotate di interruttore magnetotermico. L'azionamento dell'interruttore tramite manovra esterna agisce sulle operazioni di chiusura/apertura che avvengono all'interno di un'apposita camera antideflagrante garantendo così il contenimento di eventuali esplosioni in presenza di gas. Il circuito elettrico viene collegato solo dopo che la spina serie SPYN è stata correttamente inserita nella sua sede e la sua estrazione è garantita solo dopo aver scollegato il circuito elettrico.

Interruttore automatico interno in posizione "ON".

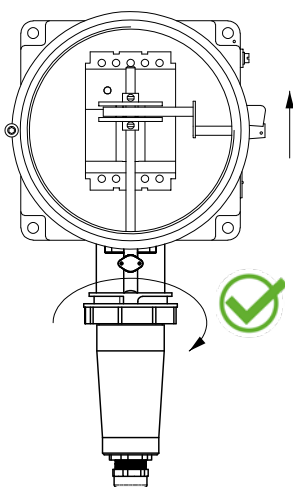

Interruttore automatico interno in posizione "ON".

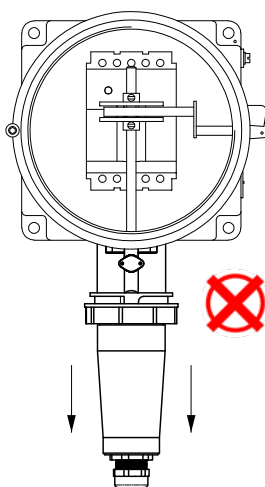

Interruttore automatico interno in posizione "SPENTO".

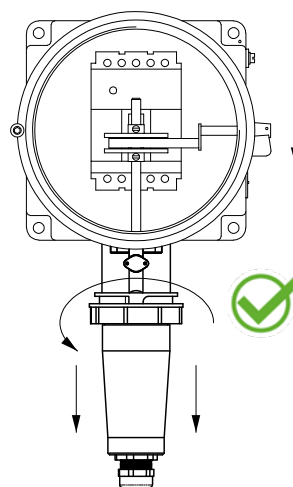

La spina non può essere rimossa dalla presa se l'interruttore è in posizione "ON" (con la manovra rivolta verso l'alto).